



Milesight

# EM500 Series

## User Guide



## Applicability

This guide is applicable to EM500 series sensors shown as follows, except where otherwise indicated.

Model	Description
EM500-CO <sub>2</sub>	Carbon Dioxide Sensor
EM500-LGT	Light Sensor
EM500-PP	Pipe Pressure Sensor
EM500-PT100	PT100 Temperature Sensor
EM500-SMT	Soil Moisture Sensor
EM500-SMTC	Soil Moisture Moisture, Temperature and Conductivity Sensor
EM500-SWL	Submersible Level Sensor
EM500-UDL	Ultrasonic Distance/Level Sensor

## Safety Precautions

Milesight will not shoulder responsibility for any loss or damage resulting from not following the instructions of this operating guide.

- ❖ The device must not be remodeled in any way.
- ❖ The device is not intended to be used as a reference sensor, and Milesight will not should responsibility for any damage which may result from inaccurate readings.
- ❖ Do not place the device close to objects with naked flames.
- ❖ Do not place the device where the temperature is below/above the operating range.
- ❖ Make sure electronic components do not drop out of the enclosure while opening.
- ❖ When installing the battery, please install it accurately, and do not install the reverse or wrong model.
- ❖ The device must never be subjected to shocks or impacts.

## Declaration of Conformity

EM500 series is in conformity with the essential requirements and other relevant provisions of the CE, FCC, and RoHS.

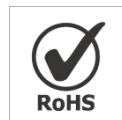

© 2011-2021 Xiamen Milesight IoT Co., Ltd.

All rights reserved.

All information in this guide is protected by copyright law. Whereby, no organization or individual shall copy or reproduce the whole or part of this user guide by any means without written authorization from Xiamen Milesight IoT Co., Ltd.



For assistance, please contact  
Milesight technical support:  
Email: [iot.support@milesight.com](mailto:iot.support@milesight.com)  
Tel: 86-592-5085280  
Fax: 86-592-5023065

### Revision History

Date	Doc Version	Description
Nov. 23, 2020	V 1.0	Initial version



# Contents

1. Product Introduction.....	5
1.1 Overview.....	5
1.2 Features.....	5
2. Hardware Introduction.....	5
2.1 Hardware Overview.....	5
2.2 Dimensions(mm).....	6
2.3 Power Button Descriptions.....	7
3. Basic Configuration.....	8
3.1 Configuration via Smartphone APP.....	8
3.1.1 Read/Write Configuration via NFC.....	8
3.1.2 Template Configuration.....	9
3.2 Configuration via PC.....	10
3.2.1 Log in the Toolbox.....	10
3.2.2 Basic Configuration.....	12
3.2.3 Template Settings.....	13
3.2.4 Upgrade.....	13
4. Advanced Feature Description.....	14
4.1 LoRaWAN Settings.....	14
4.2 Basic Settings.....	15
4.3 Calibration.....	15
4.4 Threshold and Alarm.....	15
5. Milesight IoT Cloud Management.....	16
5.1 Add a Milesight Gateway.....	16
5.2 Add EM500 to Milesight IoT Cloud.....	17
6. Sensor Payload.....	18
6.1 Basic Information.....	18
6.2 Sensor Data.....	18
6.3 Downlink Commands.....	20
Appendix.....	20
Default LoRaWAN Parameters.....	20
Default Uplink Channels.....	21

## 1. Product Introduction

### 1.1 Overview

EM500 series is a sensor mainly used for outdoor environment through wireless LoRa network. EM500 device is battery powered and designed for multiple mounting ways. It is equipped with NFC (Near Field Communication) and can easily be configured by a smartphone or a PC software.

Sensor data are transmitted in real-time using standard LoRaWAN<sup>®</sup> protocol. LoRaWAN<sup>®</sup> enables encrypted radio transmissions over long distance while consuming very little power. The user can obtain sensor data and view the trend of data change through Milesight IoT Cloud or through the user's own Network Server.

### 1.2 Features

- Up to 11km communication range
- Easy configuration via NFC
- Standard LoRaWAN<sup>®</sup> support
- Milesight IoT Cloud compliant
- Low power consumption with 19000mAh replaceable battery

## 2. Hardware Introduction

EM500 series sensors is made up of a LoRa transceiver and a sensor. Among them, ultrasonic sensors and gas sensors are combined with LoRa transceiver.

### 2.1 Hardware Overview



#### Front View of EM500:

- ① LoRa Antenna (Internal)
- ② NFC Area
- ③ Water-proof Connector



**Front View of EM500-CO<sub>2</sub>:**

- ① LoRa Antenna (Internal)
- ② NFC Area
- ③ Vent Tube



**Front View of EM500-UDL:**

- ① LoRa Antenna (Internal)
- ② NFC Area
- ③ Ultrasonic Horn

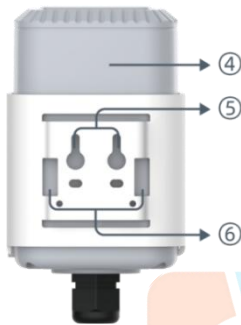

**Back View:**

- ④ Battery (Internal)
- ⑤ Wall Mounting Holes
- ⑥ Pole Mounting Holes

**2.2 Dimensions(mm)**

**EM500**

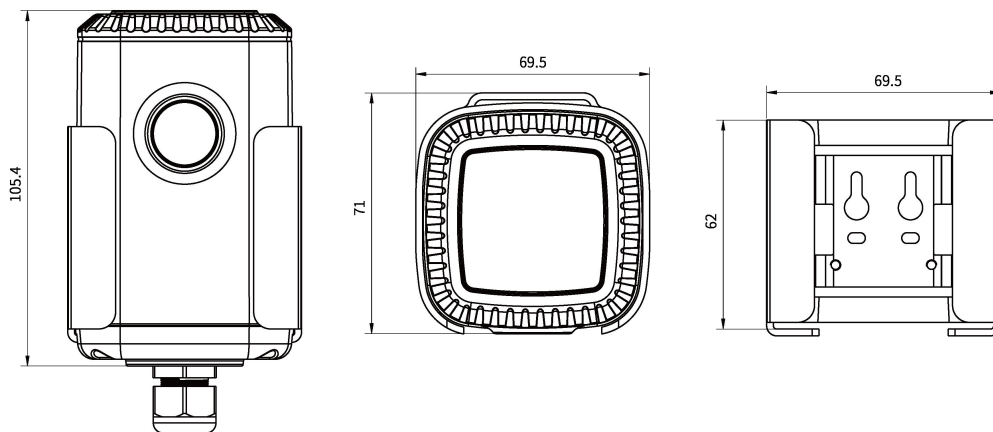

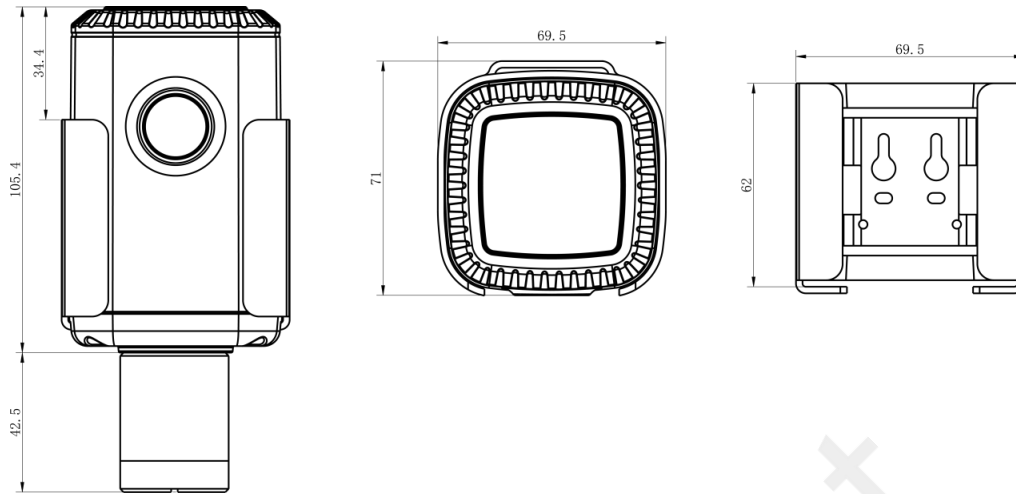
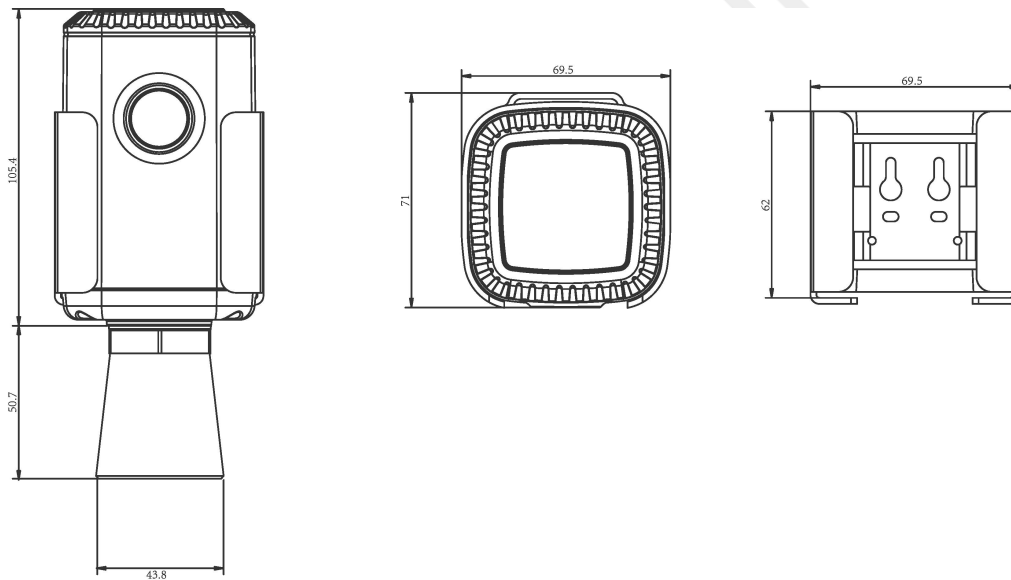
**EM500-CO<sub>2</sub>****EM500-UDL****2.3 Power Button Descriptions**

**Note:** EM500 can also be turned on/off and reset via Mobile APP or Toolbox.

Function	Action	LED Indication
Turn On	Press and hold the button for more than 3s.	Off → <b>Static Green</b>
Turn Off	Press and hold the button for more than 3s.	<b>Static Green</b> -> Off
Reset	Press and hold the button for more than 10s. <b>Note:</b> EM500 will automatically power on after reset.	Blink 3 times.
Check On/Off Status	Quickly press the power button.	<b>Light On:</b> Device is on. <b>Light Off:</b> Device is off.

### 3. Basic Configuration

EM500 sensor can be monitored and configured via one of the following methods:

- Mobile APP (NFC);
- Windows software (NFC or Type-C port).

In order to protect the security of sensor, password validation is required when configuring via unused phone . Default password is **123456**.

#### 3.1 Configuration via Smartphone APP

##### Preparation:

- Smartphone (NFC supported)
- Toolbox APP: download and install from Google Play or Apple Store.

##### 3.1.1 Read/Write Configuration via NFC

1. Enable NFC on the smartphone and open "Toolbox" APP.
2. Attach the smartphone with NFC area to the device to read basic information.

**Note:** Ensure the location of smartphone NFC area and it is recommended to take off phone case before using NFC.

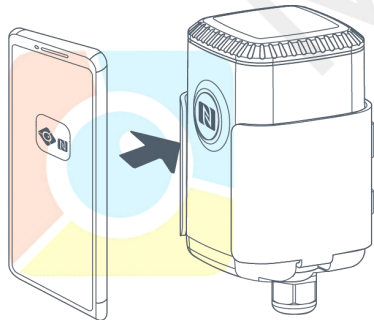

EM500-UDL-868M		
Status	Setting	Reset
SN	6126A21775363003	
Model	EM500-UDL-868M	
PN	W100	
Device EUI	24e124126a217753	
Firmware Version	V2.25	
Hardware Version	V1.2	
Device Status	Off	<input type="checkbox"/>

3. Change the on/off status or parameters, then attach the smartphone with NFC area to the device until the APP shows a successful prompt.

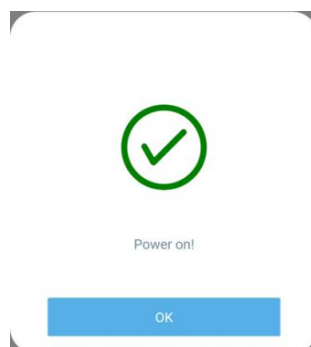





3. Select the template file from Toolbox APP and tap “Write”, keep the two devices close until the APP shows a successful prompt.

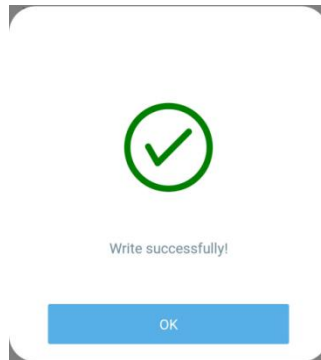

4. Slide the template item to the left to edit or delete the template.

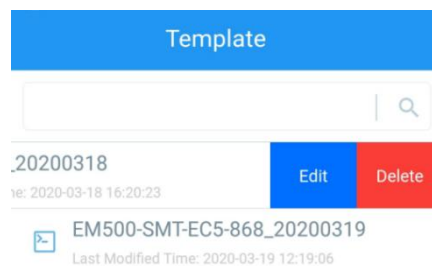

## 3.2 Configuration via PC

### Preparation:

- Dedicated NFC Reader or Type-C USB cable
- PC (Windows 10 is recommended)
- Toolbox: <https://www.milesight-iot.com/software-download/>

### 3.2.1 Log in the Toolbox

Make sure “Toolbox” is downloaded on your computer. Select one of the following methods to log in Toolbox.

#### Type-C Connection

1. Open the case of EM500 and connect the EM500 to computer via type-C port.



2. Select type as “General” and click password to log in Toolbox. (Default password: 123456)

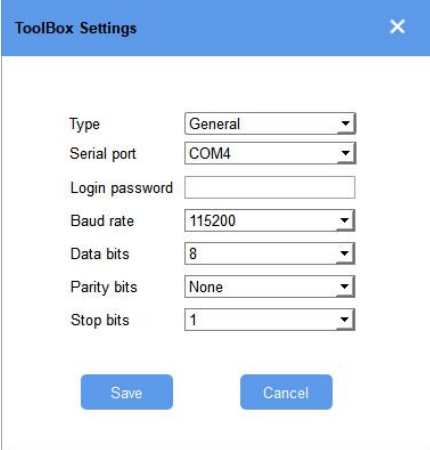

**ToolBox Settings**

Type: General

Serial port: COM4

Login password:

Baud rate: 115200

Data bits: 8

Parity bits: None

Stop bits: 1

Save Cancel

## NFC Connection

1. Connect the NFC reader to computer, then attach the EM500 to NFC area of the reader.

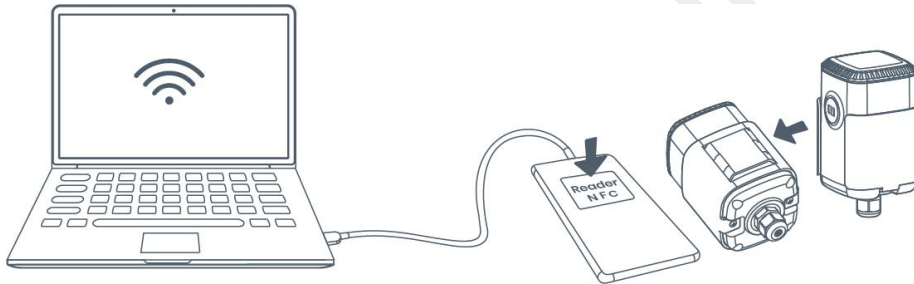

2. Select type as “NFC” and serial port as NFC reader port on Toolbox.

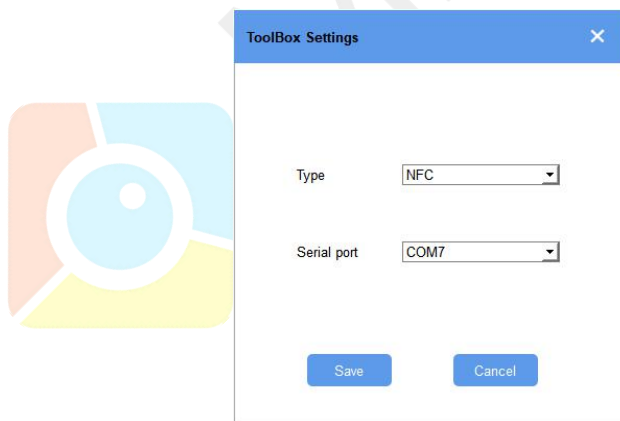

**ToolBox Settings**

Type: NFC

Serial port: COM7

Save Cancel

### 3.2.2 Basic Configuration

1. Click “Read” to read current data of the sensor.

**Status >** Read Power Off

Model:	EM500-UJDL-868M
Serial Number:	6126A21775363003
PN:	W100
Device EUI:	24E124126A217753
Firmware Version:	02.25
Hardware Version:	1.2
Device Status:	On
Join Status:	Activate
RSSI/SNR:	-51/9
Distance / Level:	0.685 m
Battery:	100%
Channel Mask:	0007
Uplink Frame-counter:	2
Downlink Frame-counter:	0

2. When you perform one of the following operations, enter the password and wait a few seconds until toolbox shows a successful prompt. (Password is not need if you connect it via type-C port)

- Turn on/off the sensor
- Reset the sensor
- Click “Write” to change settings
- Upgrade

**LoRaWAN >** Read Write

**Basic** **Channel**

Device EUI: 24E124128A215862

**Verify Password** ✕

Password:

Please put the NFC antenna close to the NFC reader.

Regular Report Confirmed

ADR Mode

Downlink Frame-counter: 1

**Success** Firmware Version: 01.01

### 3.2.3 Template Settings

**Note:** Template function is allowed only for sensors with the same model and LoRa frequency band.

1. Go to “Maintenance -> Template and Reset” page in Toolbox.
2. Click “Export” to save the current settings as a template.
3. Click “Browse” to select the correct template from computer.
4. Click “Import” to import the template to the device.



### 3.2.4 Upgrade

1. Download firmware on your computer.
2. Go to “Maintenance -> Upgrade” page in Toolbox.
3. Click “Browse” and select the firmware from computer.
4. Click “Upgrade” to upgrade the device.

**Note:** If NFC connection is selected, please keep the two devices close and don't move them in order to get the best connectivity as possible when upgrading.

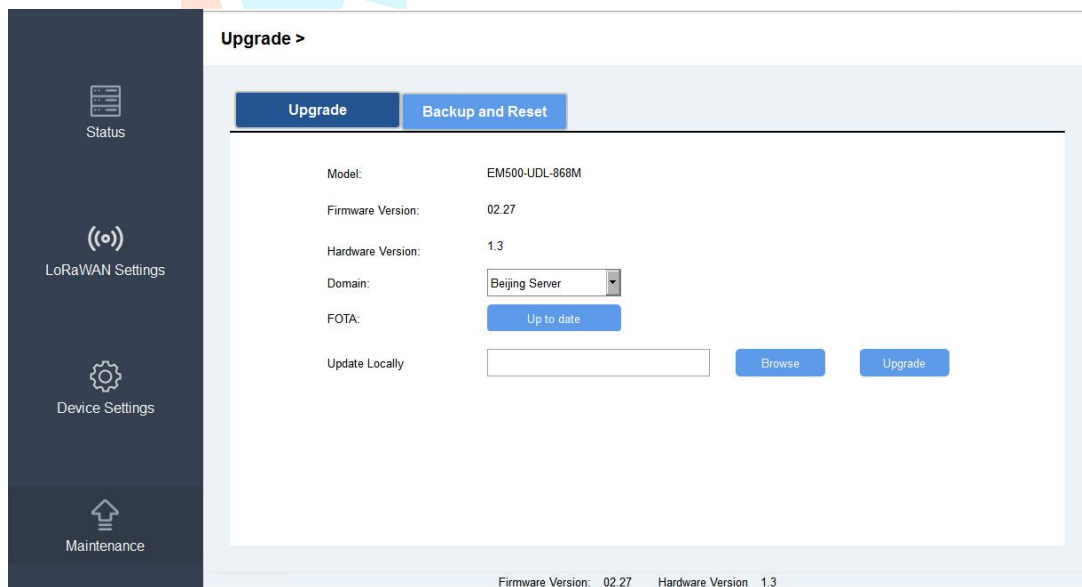

## 4. Advanced Feature Description

### 4.1 LoRaWAN Settings

Parameters	Description	Default
Device EUI	Unique ID of the sensor. It can be found on the label.	On the label
App EUI	App EUI of the sensor.	24E124C0002A0001
Application Port	The port used for sending or receiving data. Default:	85
Join Type	OTAA or ABP mode. <b>Note:</b> If you use Milesight IoT cloud to manage sensors, please select OTAA mode.	OTAA
Application Key	Appkey of the sensor.	5572404C696E6B4C 6F52613230313823
Network ID	NetID of the sensor used for identifying LoRaWAN networks.	0x010203
Device Address	DevAddr of the sensor.	The 5 <sup>th</sup> to 12 <sup>th</sup> digits of SN.
Network Session Key	Nwkskey of the sensor.	5572404C696E6B4C 6F52613230313823
Application Session Key	Appskey of the sensor.	5572404C696E6B4C 6F52613230313823
Spread Factor	Select spread factor from SF7 to SF12.	SF10-DR2
Confirmed Mode	If the sensor does not receive ACK package from network server, it will resend data 3 times most.	Disabled
Rejoin Mode	Sensor will send specific mounts of LoRaMAC packages to check connection status regularly. If no reply after specific packages, the sensor will re-join.	Enabled, 8 packages
ADR Mode	Allow network server to adjust datarate of the sensor.	Enabled
Support Frequency	LoRaWAN region.	EU868 AU915

Channel	<p>Enable or disable LoRa channels.</p> <p>If frequency is one of CN470/AU915/US915, you can enter the index of the channel that you want to enable in the input box, making them separated by commas.</p> <p><b>Examples:</b></p> <p>1, 40: Enabling Channel 1 and Channel 40</p> <p>1-40: Enabling Channel 1 to Channel 40</p> <p>1-40, 60: Enabling Channel 1 to Channel 40 and Channel 60</p> <p>All: Enabling all channels</p> <p>Null: Indicates that all channels are disabled</p>	<p><a href="#">Appendix</a></p>
---------	---	---------------------------------

## 4.2 Basic Settings

Parameters	Description
Reporting Interval	Interval of sending sensor data. Default: 10min.
Change Password	Change the password of logging Toolbox (Windows) and parameter modify(mobile APP).

## 4.3 Calibration

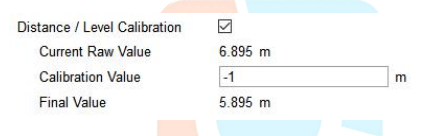
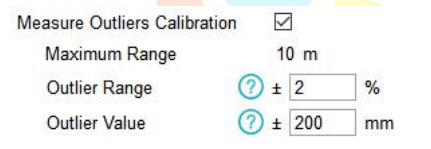
Parameters	Description
 <p>Distance / Level Calibration <input checked="" type="checkbox"/></p> <p>Current Raw Value 6.895 m</p> <p>Calibration Value <input type="text" value="-1"/> m</p> <p>Final Value 5.895 m</p>	<p>After saving the calibration value, the sensor will add the calibration value to raw value and send the final value.</p>
 <p>Measure Outliers Calibration <input checked="" type="checkbox"/></p> <p>Maximum Range 10 m</p> <p>Outlier Range <input type="text" value="± 2"/> %</p> <p>Outlier Value <input type="text" value="± 200"/> mm</p>	<p>If current value exceeds the outlier range/values, the sensor will re-collect the value.</p> <p><b>Note:</b> This item is only for EM500-UDL.</p>

## 4.4 Threshold and Alarm

Parameters	Description
Over/Below	Maximum/minimum data to trigger the alarm. After triggered, sensor will send current data ignoring report interval.
Data Collecting Interval	The sensor will detect and check whether the value is triggered again after data collecting interval.

## 5. Milesight IoT Cloud Management

EM500 sensors can be managed by Milesight IoT Cloud platform. Milesight IoT cloud is a comprehensive platform that provides multiple services including device remote management and data visualization with the easiest operation procedures. Please register a Milesight IoT Cloud account before operating following steps.

### 5.1 Add a Milesight Gateway

1. Enable “Milesight” type network server and “Milesight IoT Cloud” mode in gateway web GUI.

**Note:** Ensure gateway has accessed the Internet.

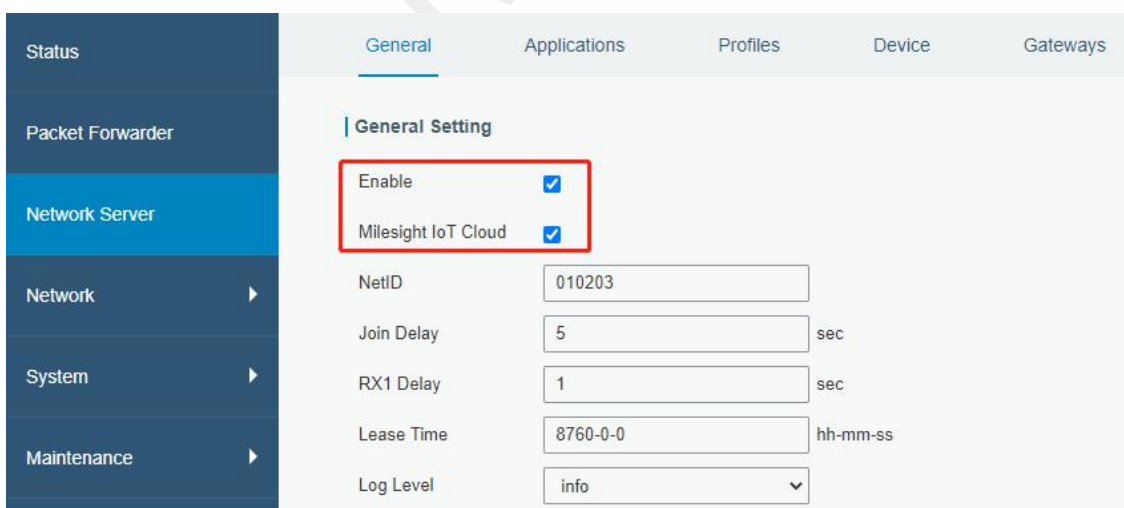
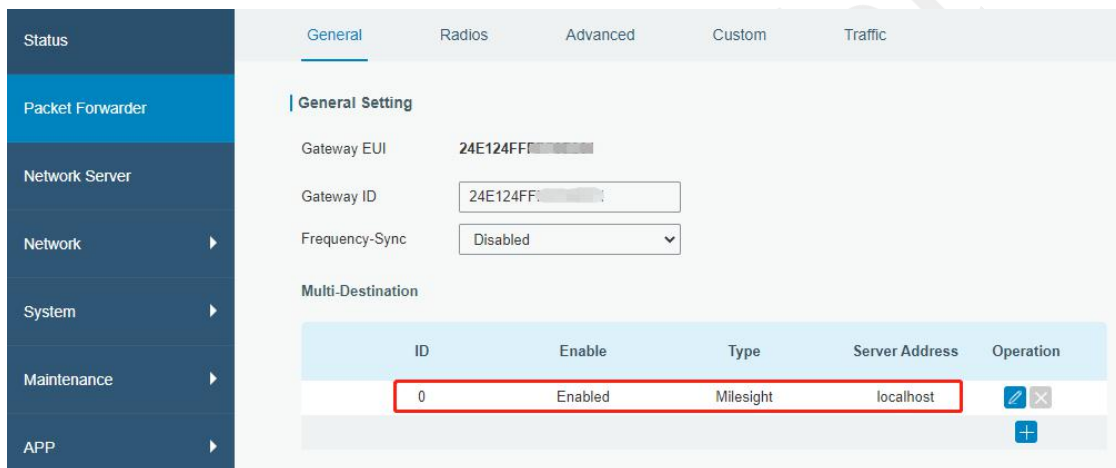

2. Go to “My Devices” page and click “+New Devices” to add gateway to Milesight IoT Cloud via SN. Gateway will be added under “Gateways” menu.



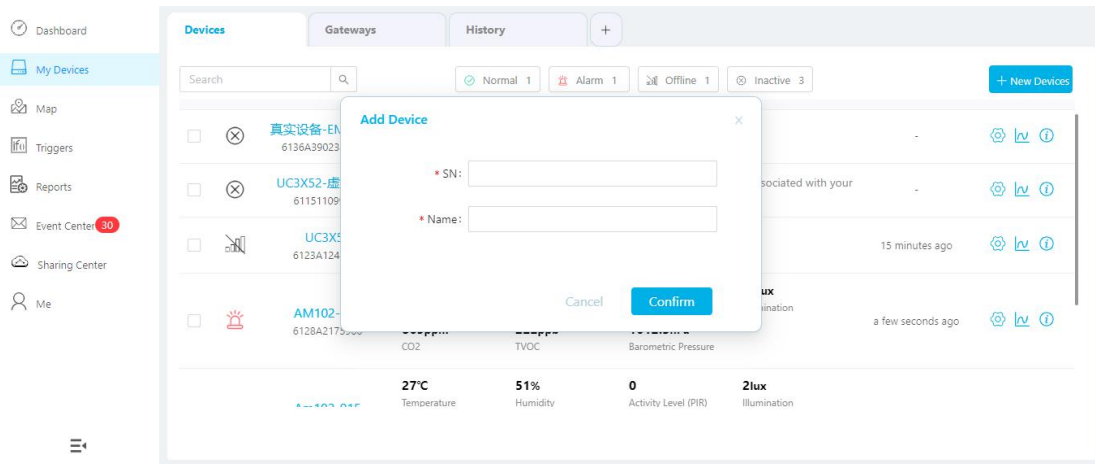

### 3. Check if gateway is online in Milesight IoT Cloud.

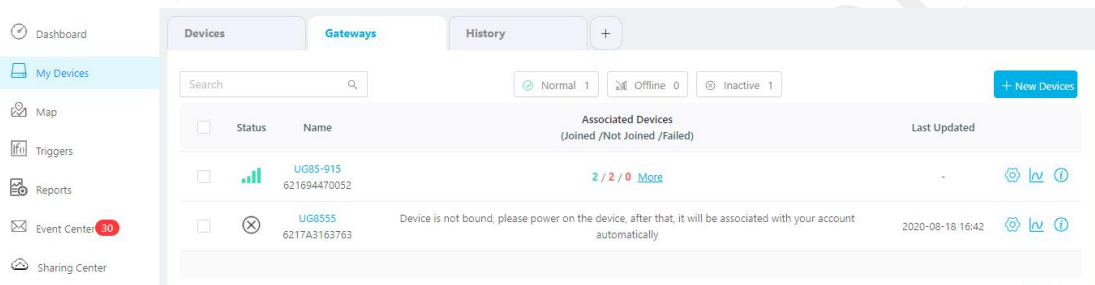

## 5.2 Add EM500 to Milesight IoT Cloud

1. Go to "My Devices" page and click "+New Devices". Fill in the SN of EM500 and select associated gateway.

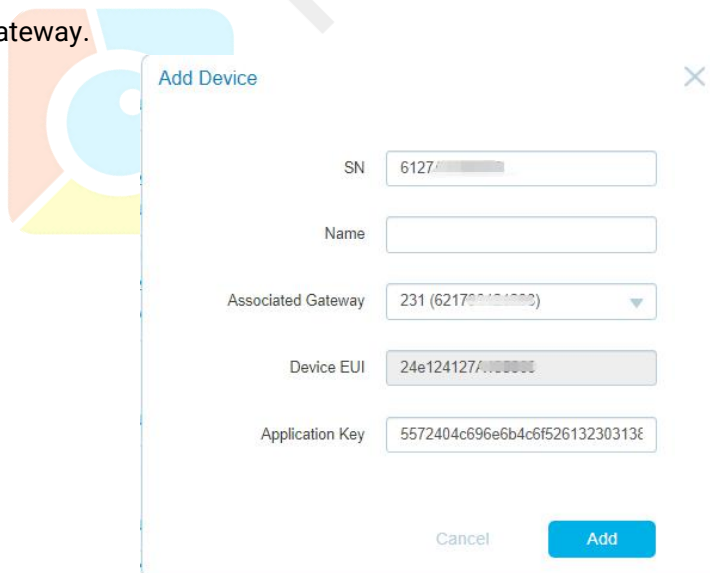

2. After EM500 is connected to Milesight IoT Cloud, you could check the device information and data and create dashboard for it.

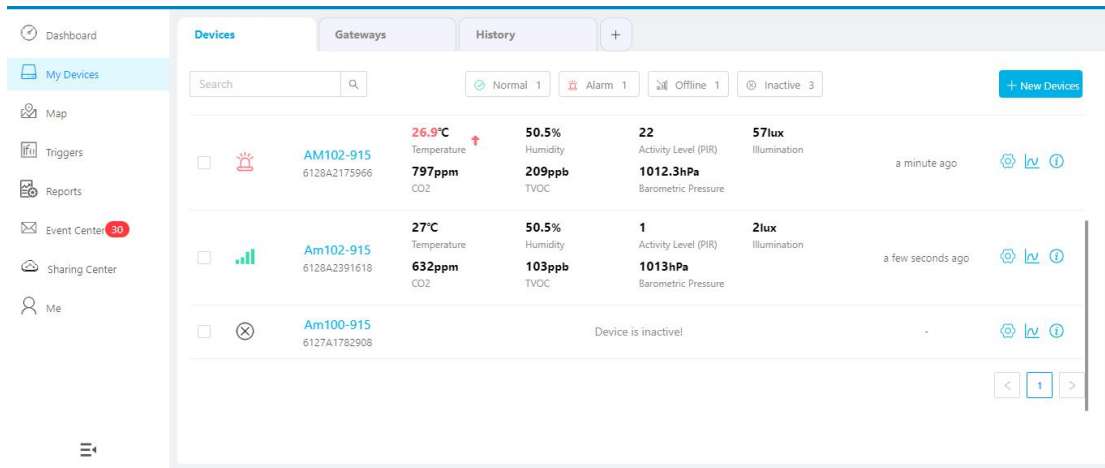

## 6. Sensor Payload

All data are based on following format(HEX):

Channel1	Type1	Data1	Channel2	Type2	Data2	Channel 3	...
1 Byte	1 Byte	N Bytes	1 Byte	1 Byte	M Bytes	1 Byte	...

### 6.1 Basic Information

EM500 sensors report basic information of sensor everytime joining the network.

Channel	Type	Data Example	Description
ff	01(Milesight Protocol Version)	01	V1
	09 (Hardware Version)	01 40	V1.4
	0a(Software Version)	01 14	V1.14
	0f(Device Type)	00	Class A
	16 (Device SN)	64 10 90 82 43 75 00 01	Device SN is 6410908243750001

### 6.2 Sensor Data

EM500 sensors report sensor data according to reporting interval (10min by default). Battery level is reported every 24 hours.

#### EM500-CO<sub>2</sub>

Channel	Type	Data Example	Description
01	75(Battery Level)	64	64=>100 Battery level =100%

03	67 (Temperature)	10 01	10 01 => 01 10 = 272 Temp=272*0.1=27.2°C
04	68(Humidity)	71	71=>113 Hum=113*0.5=56.5%
05	7d (CO <sub>2</sub> )	67 04	67 04 => 04 67 =1127 ppm
06	73 (Barometric Pressure)	68 27	68 27=>27 68=10088 Pressure=10088*0.1=1008.8hPa

### EM500-LGT

Channel	Type	Data Example	Description
01	75(Battery Level)	64	64=>100 Battery level =100%
03	94 (Light)	50 00 00 00	50 00 00 00=>00 00 00 50=80 lux

### EM500-PP

Channel	Type	Data Example	Description
01	75(Battery Level)	64	64=>100 Battery level =100%
03	7b (Pressure)	0a 00	0a 00=>00 0a=10kPa

### EM500-PT100

Channel	Type	Data Example	Description
01	75(Battery Level)	64	64=>100 Battery level =100%
03	67 (Temperature)	10 01	10 01 => 01 10 = 272 Temp=272*0.1=27.2°C

### EM500-SMT/SMTC

Channel	Type	Data Example	Description
01	75(Battery Level)	64	64=>100 Battery level =100%

03	67 (Temperature)	10 01	10 01 => 01 10 = 272 Temp=272*0.1=27.2°C
04	68(Moisture)	71	71=>113 Hum=113*0.5=56.5%
05	7d (Conductivity)	f0 00	f0 00 => 00 f0 =240 µs/cm

## EM500-SWL

Channel	Type	Data Example	Description
01	75(Battery Level)	64	64=>100 Battery level =100%
03	77 (Water Level)	02 00	02 00=>00 02=2cm

## EM500-UDL

Channel	Type	Data Example	Description
01	75(Battery Level)	64	64=>100 Battery level =100%
03	82 (Distance)	1e 00	1e 00=>00 1e=30mm

## 6.3 Downlink Commands

EM500 sensors support downlink commands to configure the device. Application port is 85 by default.

Channel	Type	Data Example	Description
ff	03(Set Reporting Interval)	b0 04	b0 04 => 04 b0 = 1200s

## Appendix

### Default LoRaWAN Parameters

<b>DevEUI</b>	24E124 + 2 <sup>nd</sup> to 11 <sup>th</sup> digits of SN e.g. SN = 61 26 A1 01 84 96 00 41 Then Device EUI = 24E124126A101849
<b>AppEUI</b>	24E124C0002A0001

<b>Appport</b>	0x55
<b>NetID</b>	0x010203
<b>DevAddr</b>	The 5 <sup>th</sup> to 12 <sup>th</sup> digits of SN e.g. SN = 61 26 A1 01 84 96 00 41 Then DevAddr = A1018496
<b>AppKey</b>	5572404C696E6B4C6F52613230313823
<b>NwkSKey</b>	5572404C696E6B4C6F52613230313823
<b>AppSKey</b>	5572404C696E6B4C6F52613230313823

### Default Uplink Channels

Model	Channel Plan	Channel Settings/MHz
EM500-470M	CN470	470.3~489.3(All 95 channels)
EM500-868M	EU868	868.1, 868.3, 868.5
	RU864	868.9, 869.1
	IN865	865.0625, 865.4025, 865.6025
EM500-915M	AU915	915.2~927.1 (All 72 channels)
	US915	902.3~914.2 (All 72 channels)
	KR920	922.1, 922.3, 922.5
	AS923	923.2, 923.4

**-END-**

