



Radar Human Presence Sensor

Featuring LoRaWAN®

VS370



Safety Precautions

Milesight will not shoulder responsibility for any loss or damage resulting from not following the instructions of this operating guide.

- ❖ The device must not be disassembled or remodeled in any way.
- ❖ The device is not intended to be used as a reference sensor, and Milesight will not hold responsibility for any damage which may result from inaccurate readings.
- ❖ Do not place the device in places where the temperature is below/above the operating range.
- ❖ Do not place the device near naked flames, heat source (such as oven), or expose it to sunlight, cold source, liquid, and with extreme temperature changes.
- ❖ Remove the battery from the device if it is not to be used for an extended period. Otherwise, the battery might leak and damage the device.
- ❖ The device must never be subjected to shocks or impacts.

Declaration of Conformity

VS370 is in conformity with the essential requirements and other relevant provisions of the CE, FCC, and RoHS.

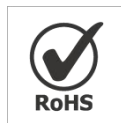

Copyright © 2011-2024 Milesight. All rights reserved.

All information in this guide is protected by copyright law. Whereby, no organization or individual shall copy or reproduce the whole or part of this user guide by any means without written authorization from Xiamen Milesight IoT Co., Ltd.

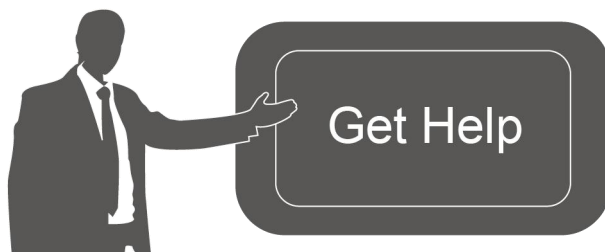

For assistance, please contact

Milesight technical support:

Email: iot.support@milesight.com

Support Portal: support.milesight-iot.com

Tel: 86-592-5085280

Fax: 86-592-5023065

Address: Building C09, Software Park
Phase III, Xiamen 361024,
China

Revision History

Date	Doc Version	Description
Dec. 10, 2024	V1.0	Initial version

Contents

1. Product Introduction	5
1.1 Overview	5
1.2 Key Features	5
2. Hardware Introduction	5
2.1 Packing List	5
2.2 Hardware Overview	6
2.3 Button Descriptions	7
2.4 Dimensions (mm)	7
3. Power Supply	7
4. Operation Guide	8
4.1 NFC & Bluetooth Configuration	8
4.2 Time Synchronization	9
4.3 LoRaWAN® Settings	10
4.4 General Settings	13
4.5 Milesight D2D Settings	14
4.6 Maintenance	16
4.6.1 Backup	16
4.6.2 Upgrade	18
4.6.3 Reset	19
5. Installation Instruction	20
5.1 Detection Range	20
5.2 Installation	20
5.3 Factors Affecting Accuracy	24
6. Communication Protocol	24
6.1 Basic Information	24
6.2 Sensor Data	25
6.3 Downlink Commands	26

1. Product Introduction

1.1 Overview

VS370 is a LoRaWAN® Radar Human Presence Sensor that adopts Millimeter Wave Radar and PIR technology. The sensor can detect human presence or slight movement and provide accurate human mobility statistics. Without any violation of privacy, VS370 has high detection accuracy with remarkable sensitivity, excellent algorithm performance, and exceptional precision.

As a Milesight D2D controller, the VS370 seamlessly communicates with other Milesight D2D devices, establishing more possible connections and paving the way for smoother operations. It can also be linked with lighting control and HVAC system to achieve an automated scene deployment where the lights, HVAC system and other associated devices turn on when someone enters the room.

With easy configuration and wireless detection, VS370 can be integrated with Milesight LoRaWAN® gateway and Milesight Development Platform, enabling remote and visual management of all sensor data.

VS370 can be used in various meeting rooms, conference rooms, and other spaces requiring monitoring of human presence.

1.2 Key Features

- Equipped with Millimeter Wave Radar and PIR technology, it can identify human slight-movement and moving object
- Detachable and movable magnetic bracket with an additional 30° deflection angle to achieve full area coverage
- 100% privacy protection, no specific images will be captured
- Working well even in low-light or completely dark environments with great lighting adaptability
- Support the sensitivity configuration of PIR and radar sensors, allowing for the selection of different sensitivity levels based on actual scenarios
- Support Milesight D2D protocol to enable ultra-low latency and direct control without gateways
- Support customized hibernation periods to achieve flexible control and save battery power
- Easy configuration via NFC and Bluetooth
- Support management and OTA upgrade via Milesight Development Platform

2. Hardware Introduction

2.1 Packing List



1 x VS370 Sensor



1 x Magnetic Bracket

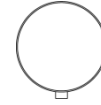

1 x Bracket Adhesive



2 x ER14505 Li-SOCl₂
Batteries



1 x
Quick Start Guide



1 x
Warranty Card

 **If any of the above items are missing or damaged, please contact your sales representative.**

2.2 Hardware Overview

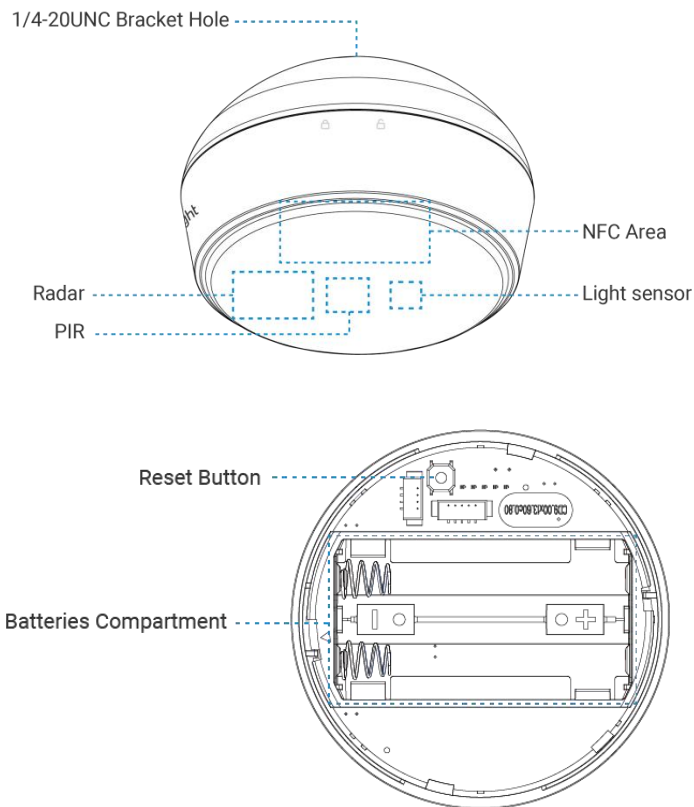

2.3 Button Descriptions

Function	Action
Power On/Off	Install the batteries
	Remove the batteries
Reboot	Press and hold reset button for over 3s
Reset to Factory Default	Press and hold reset button for over 10s

2.4 Dimensions (mm)

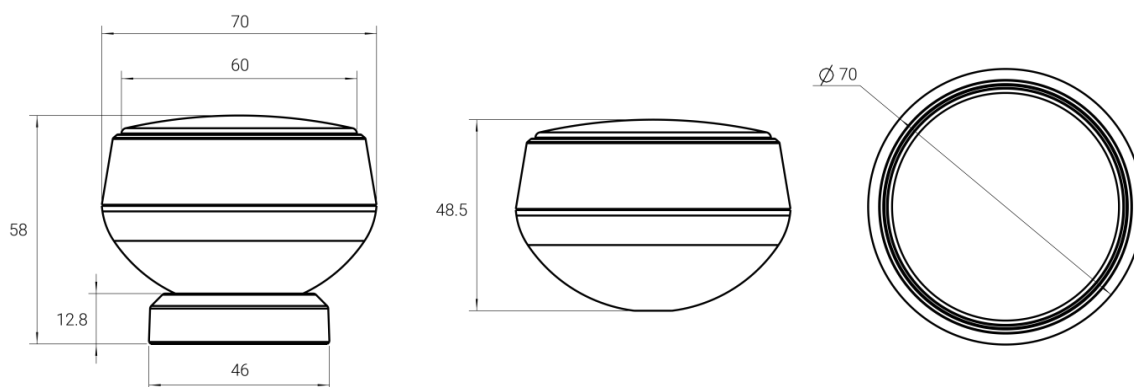

3. Power Supply

Hold the back cover and rotate counterclockwise.

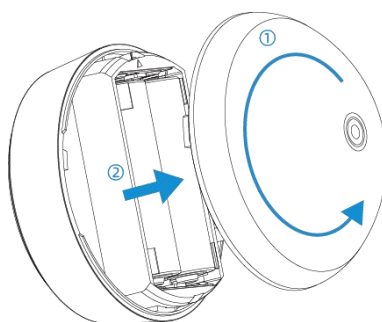

Install the two batteries according to the markings.

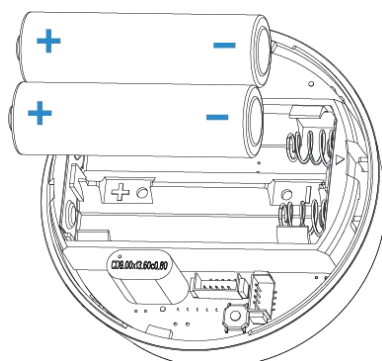

Align the mark with the unlock logo, then rotate to the left to secure the back cover.

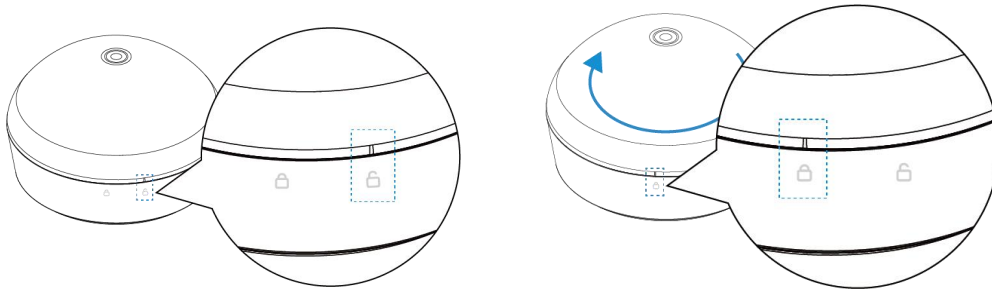

Note:

- 1) The device can only be powered by ER14505 Li-SOCl₂ batteries and does not support the use of alkaline batteries.
- 2) If the device is not used for a long period of time, please remove the batteries, otherwise it may cause battery leakage and damage to the internal components.
- 3) When replacing batteries, ensure all batteries are newest; otherwise, it may shorten battery life or cause inaccurate power calculations.

4. Operation Guide

4.1 NFC & Bluetooth Configuration

After the device is powered on, it can be configured via Bluetooth or NFC. Bluetooth is recommended for the first time installation.

NFC Configuration:

1. Download and install “Milesight ToolBox App” on an NFC-supported smartphone.
2. Enable NFC on the smartphone and open “Milesight ToolBox” App.
3. Open “Milesight ToolBox” App, attach the smartphone with NFC area to read/write the device until App shows a successful prompt. It’s suggested to configure a device password for security. (Default password: 123456)

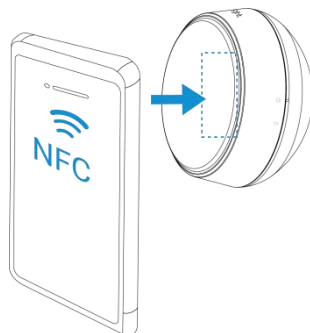

4. Basic information and settings of devices will be shown on ToolBox if it’s recognized successfully.

Note:

- 1) Ensure the location of smart phone NFC area and it's recommended to take off phone case.
- 2) If the smartphone fails to read/write configurations via NFC, move the phone away and try again.

Bluetooth Configuration:

1. Download and install "Milesight ToolBox" App on an Bluetooth-supported smartphone.
2. Enable Bluetooth and location function on the smartphone.
3. Open "Milesight ToolBox" App, select Bluetooth method, search for the target device, and connect entering the Bluetooth password. Read/write operations can be performed once the app shows a success message. It's suggested to configure a device password for security. (Default password: 123456)

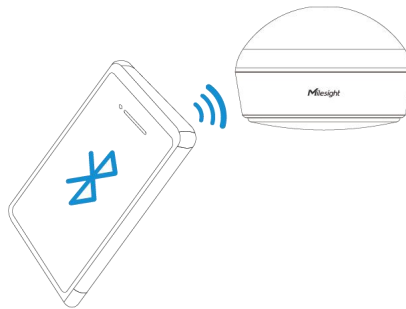
**Note:**

- 1) The Bluetooth connection will be terminated if there's no data interaction within 3 minutes. It will request to connect again.
- 2) The device can connect to only one smartphone via Bluetooth at a time. For example, if the device is connected to Smart phone A via Bluetooth, the connection will be terminated after it is connected to Smartphone B.

4.2 Time Synchronization

Go to **Device > Basic Information**, click  to sync the time from smartphone.

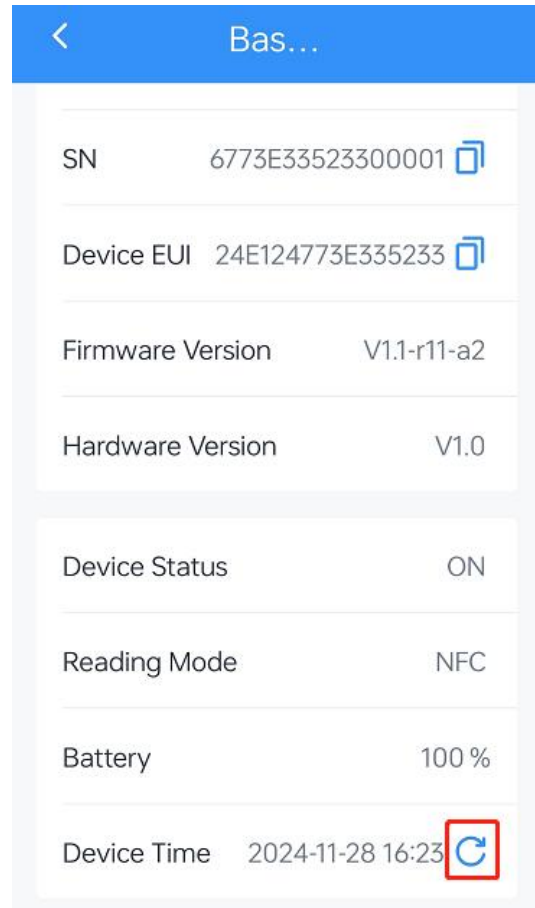
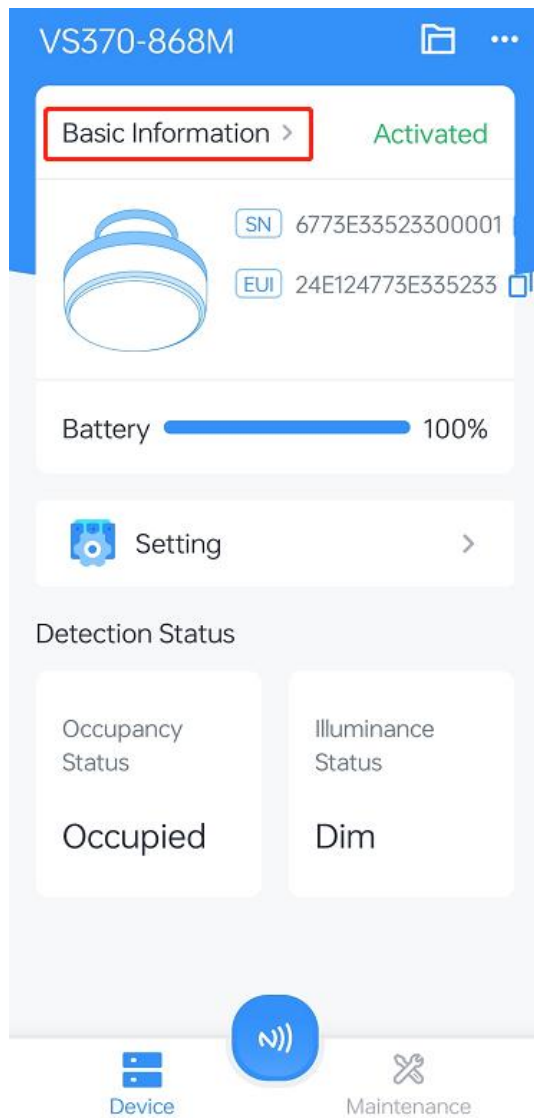

4.3 LoRaWAN® Settings

Go to **Device > Settings > Network** of ToolBox App to configure AppEUI, Join Type, Application Key, and other information. You can also keep all settings by default.

LoRaWAN D2D

Device EUI

24E124773E335233

APP EUI

24e124c0002a0001

* Application Port

85

LoRaWAN Version

V1.0.3

Parameters	Description
Device EUI	Unique ID of the device which can also be found on the label.
App EUI	The default App EUI is 24E124C0002A0001.
Application Port	The port is used for sending and receiving data, the default port is 85.
LoRaWAN® Version	V1.0.2 and V1.0.3 are available.
Work Mode	It's fixed as Class A.
Confirmed Mode	If the device does not receive an ACK packet from the network server, it will resend data once.
Join Type	OTAA and ABP modes are available.
Application Key	Appkey for OTAA mode, the default is 5572404C696E6B4C6F52613230313823.
Network Session Key	Nwkskey for ABP mode, the default is 5572404C696E6B4C6F52613230313823.
Application Session Key	Appskey for ABP mode, the default is 5572404C696E6B4C6F52613230313823.
Device Address	DevAddr for ABP mode, the default is the 5th to 12th digits of the SN.
Rejoin Mode	Reporting interval \leq 35 mins: the device will send a specific number of LinkCheckReq MAC packets to the network server every reporting interval or every double reporting interval to validate connectivity; If there is no response,

	<p>the device will re-join the network.</p> <p>Reporting interval > 35 mins: the device will send a specific number of LinkCheckReq MAC packets to the network server every reporting interval to validate connectivity; If there is no response, the device will re-join the network.</p> <p>Note: Only OTAA mode supports rejoin mode.</p>										
Set the number of packets sent	<p>When the rejoin mode is enabled, set the number of LinkCheckReq packets to send.</p> <p>Note: the actual sending number is Set the number of packet sent + 1.</p>										
Channel Mode	<p>Select Standard-Channel mode or Single-Channel mode. When Single-Channel mode is enabled, only one channel can be selected to send uplinks.</p>										
Supported Frequency	<p>Enable or disable the frequency to send uplinks.</p> <div style="border: 1px solid #ccc; padding: 5px; margin-bottom: 10px;"> <p>* Support Frequency</p> <p>EU868</p> </div> <p>Frequency/MHz</p> <table style="width: 100%; border-collapse: collapse;"> <tr> <td style="width: 60%; padding: 5px;">868.1</td> <td style="text-align: center; padding: 5px;"><input checked="" type="checkbox"/></td> </tr> <tr> <td style="padding: 5px;">868.3</td> <td style="text-align: center; padding: 5px;"><input checked="" type="checkbox"/></td> </tr> <tr> <td style="padding: 5px;">868.5</td> <td style="text-align: center; padding: 5px;"><input checked="" type="checkbox"/></td> </tr> <tr> <td style="padding: 5px;">867.1</td> <td style="text-align: center; padding: 5px;"><input type="checkbox"/></td> </tr> <tr> <td style="padding: 5px;">867.3</td> <td style="text-align: center; padding: 5px;"><input type="checkbox"/></td> </tr> </table> <p>If frequency is one of CN470/AU915/US915, enter the index of the channel that you want to enable and make them separated by commas.</p> <p>Examples:</p> <p>1, 40: Enabling Channel 1 and Channel 40</p> <p>1-40: Enabling Channel 1 to Channel 40</p> <p>1-40, 60: Enabling Channel 1 to Channel 40 and Channel 60</p> <p>All: Enabling all channels</p> <p>Null: Indicates that all channels are disabled</p>	868.1	<input checked="" type="checkbox"/>	868.3	<input checked="" type="checkbox"/>	868.5	<input checked="" type="checkbox"/>	867.1	<input type="checkbox"/>	867.3	<input type="checkbox"/>
868.1	<input checked="" type="checkbox"/>										
868.3	<input checked="" type="checkbox"/>										
868.5	<input checked="" type="checkbox"/>										
867.1	<input type="checkbox"/>										
867.3	<input type="checkbox"/>										
ADR Mode	Allow network server to adjust the data rate of the device.										
Spread Factor	If ADR is disabled, the device will send data via this spread factor.										
Tx Power	Transmit power of the device.										
RX2 Data Rate	RX2 data rate to receive downlinks.										
RX2 Frequency	RX2 frequency to receive downlinks. Unit: Hz										

Note:

- 1) Please contact sales personnel for device EUI list if there are many units.
- 2) Please contact sales personnel if you need random App keys before purchase.
- 3) Select OTAA mode if you are using Milesight Development Platform to manage devices.

4.4 General Settings

General

Reporting Interval(min)

10

Occupancy Trigger Sensitivity ⓘ

High

Occupancy Maintaining Sensitivity ⓘ

Middle

Hibernate Period ⓘ

00:00 — 00:01



00:00 — 00:01



Time Zone

UTC+8 (CT/CST: China St...)

Daylight Saving Time



Time to Report Vacancy(min) ⓘ

1

Illuminance Collection



Change Password



Parameters	Description
Reporting Interval	The interval of reporting current occupancy status, illuminance status and battery level to network server. Default: 1440 min, Range: 1 ~ 1440

	min
Occupancy Trigger Sensitivity	Adjust the responsiveness of the device to occupancy events. Higher sensitivity leads to quicker triggers but increases the probability of false triggers.
Occupancy Maintaining Sensitivity	Control the time and accuracy for maintaining the operational state after detecting presence. Higher sensitivity makes it easier to detect slight movements and maintain the occupied state.
Hibernate Period	Disable or enable Hibernate mode and configure the Hibernate Period. It will stop detecting and reporting when hibernating.
Time Zone	Set the time zone of the current location. When you click Sync button of ToolBox App to sync time, the device will also sync the time zone from smartphone automatically.
Daylight Saving Time	Enable or disable Daylight Saving Time (DST). Start Time: the start time of DST time range. End Time: the end time of DST time range. DST Bias: the DST time will be faster according to this bias setting.
Time to Report Vacancy(min)	After being released from the occupied state, it needs to wait for the idle time. If no occupancy is detected again during the idle time, the space will be considered as vacancy and the device will report a Vacant report. Default: 3min, Range: 1~60min.
Illuminance Collection	Enable or disable light intensity collection. Default: Bright status ≥ 700 lux; Dim status ≤ 300 lux. When the value is higher than 700 lux, the device will report status as Bright; when the value is lower than 300 lux, the device will report status as Dim.
Change Password	Change the password for ToolBox App to write this device.

4.5 Milesight D2D Settings

Milesight D2D protocol is developed by Milesight and used for setting up transmission among Milesight devices without a gateway. When the Milesight D2D setting is enabled, VS370 can work as a Milesight D2D controller to send control commands to trigger Milesight D2D agent devices.

1. Configure RX2 data rate and RX2 frequency in LoRaWAN[®] settings, it is suggested to change the default value if there are many LoRaWAN[®] devices around.
2. Go to **Device > Settings > Network > D2D** to enable D2D function and configure the D2D

settings.

LoRaWAN D2D

Enable

D2D Key

Occupied

Control command

0

LoRa Uplink

Control Time(min)

Vacant

Bright

Dim

Occupied/Bright

Occupied/Dim

Parameters	Description
Enable	Enable or disable Milesight D2D feature.
D2D Key	Define a unique D2D key which is the same as the setting in D2D agent devices. Default value: 5572404C696E6B4C6F52613230313823.
Status Condition	<p>When device detects one or more of the below statuses, it will send the control command to the corresponding Milesight D2D agent devices:</p> <ul style="list-style-type: none"> ● Occupied ● Vacant ● Bright ● Dim ● Occupied/Bright

	<ul style="list-style-type: none"> ● Occupied/Dim
Control command	Define a 2-byte hexadecimal control command (0x0000 to 0xffff).
LoRa Uplink	If enabled, a LoRaWAN® uplink packet that contains the information of button status will be sent to gateway after the Milesight D2D control command is sent.
Control Time /min	<p>After receiving commands from VS370, Milesight D2D agent devices will take corresponding actions within this duration.</p> <p>Default: 5 mins, Range: 1~1440 mins</p>

4.6 Maintenance

4.6.1 Backup

VS370 supports backup templates for easy and quick device configurations in bulk. The backup feature is only for devices with the same model and LoRaWAN® frequency band.

1. Click  to go to **Template** page in the App, click **Add Template** to save the current settings as a template. The saved templates are also editable.

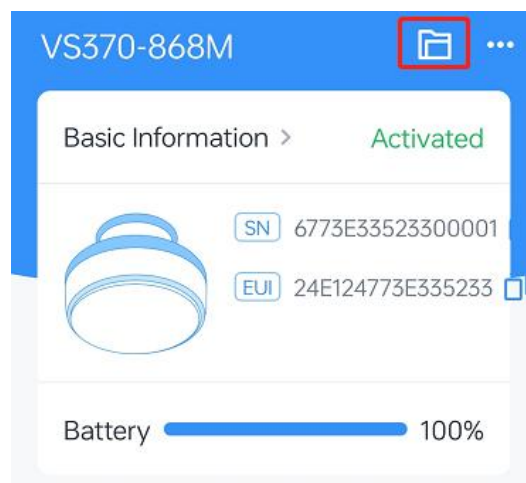

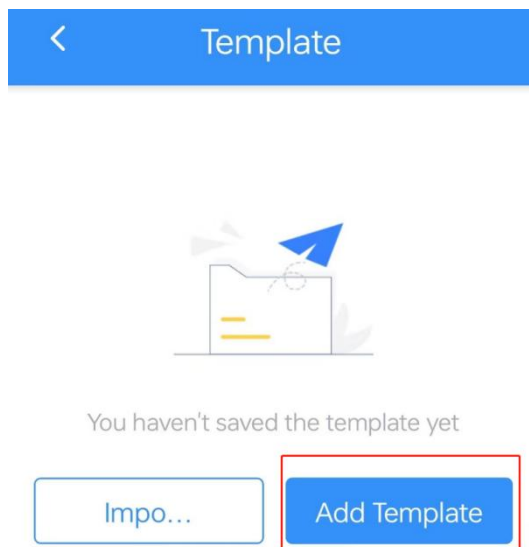

2. Modify the configuration and click **Save**, then attach the smartphone to another device, click **Write** to reuse the template.

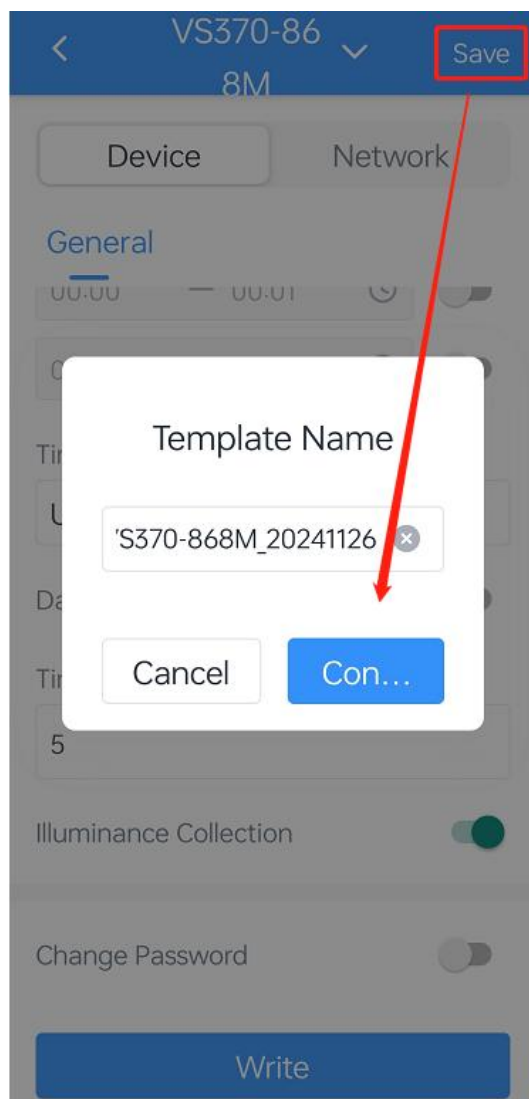

Note: Check the box to export or delete the template. Click the template to edit the

configurations.

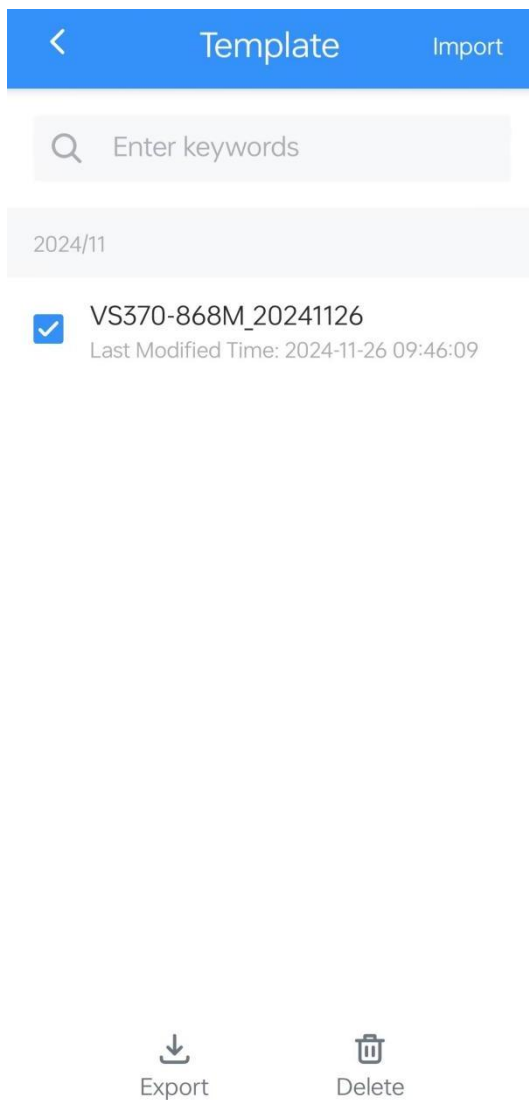

4.6.2 Upgrade

1. Download firmware from the Milesight website to your smartphone.
2. Go to **Maintenance** page of ToolBox App, and tap **Upgrade** to import firmware and upgrade the device.

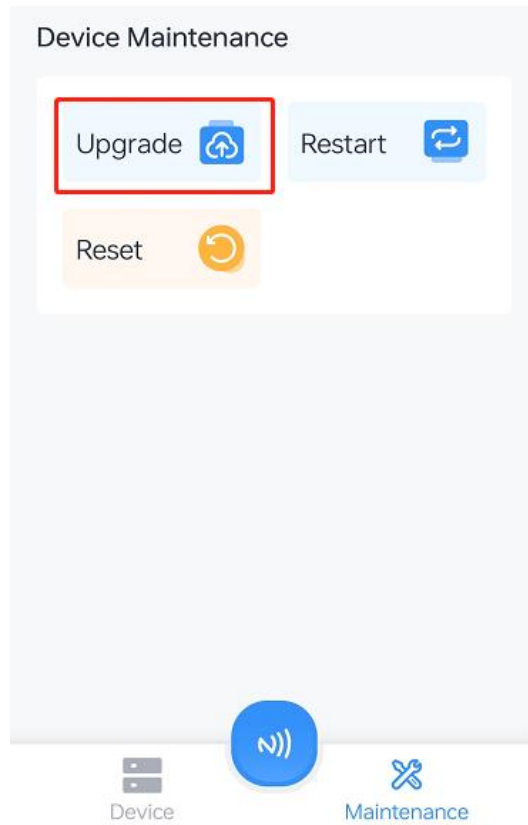

4.6.3 Reset

Go to **Maintenance** page and tap **Reset**, then attach the smartphone to the device via NFC or connect Bluetooth to complete the reset.

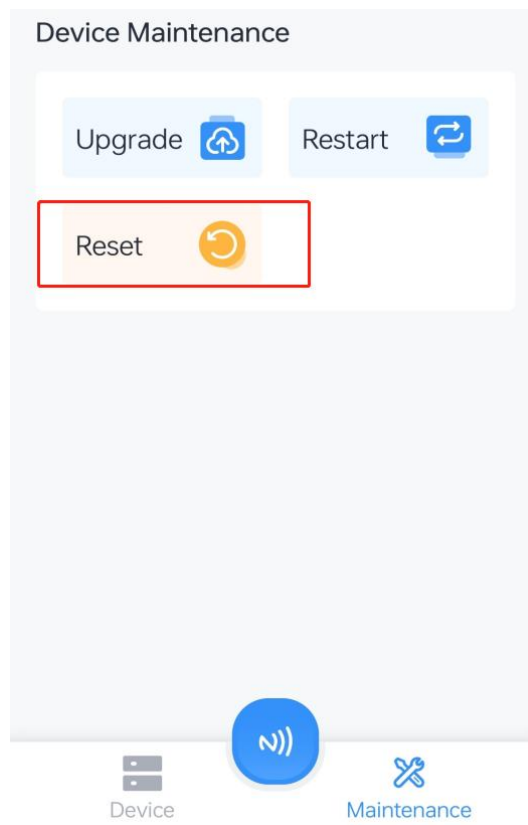

5. Installation Instruction

5.1 Detection Range

VS370 will use PIR to detect the movement first and then trigger the radar to turn on to detect the occupancy status.

Condition: Installation Height=2.7m, Angle=75°.

PIR Detection Range:

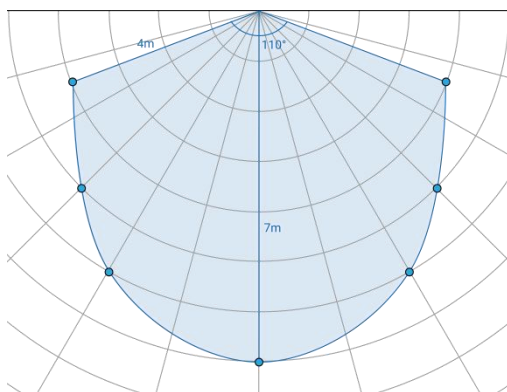

Radar Slight Movement Detection Range:

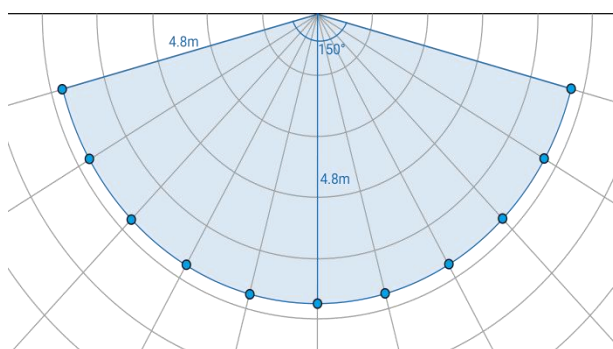

Radar Movement Detection Range:

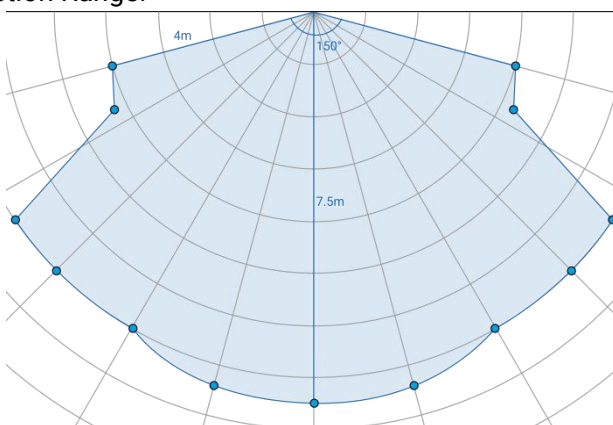

5.2 Installation

Location: On a wall at a height of 2.5 to 3 meters. Ceiling installation is not supported.

Tilt angle: 60° or 75° is recommended.

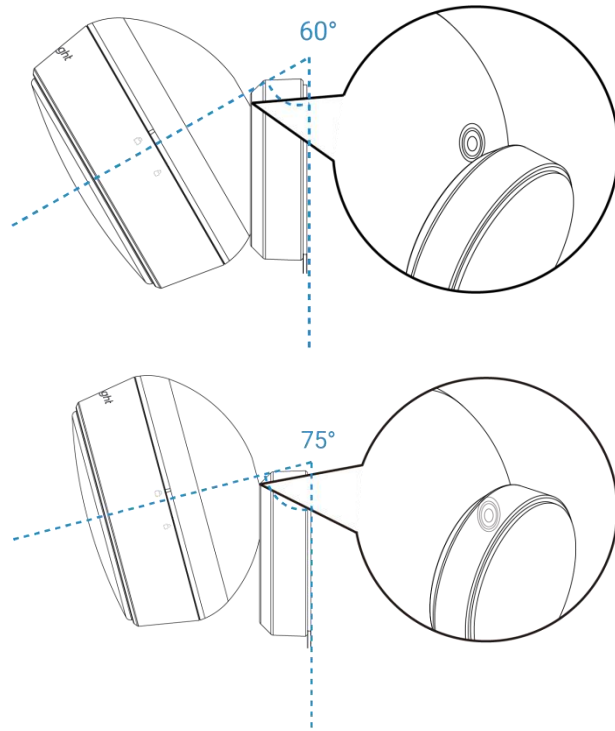

Recommended Installation Location:

Small meeting room (area $\leq 4m \times 4m$): height 2.5m, angle 60°.

<p>Detection Range</p>	
<p>Recommended Installation Location</p>	
<p>Installation Note</p>	<p>1. It is recommended to install the device directly opposite the usual seating position (Position 3). It is not recommended to install it behind the seating position (Position 1).</p> <p>2. If one side of the conference room is made of glass, please install</p>

the device on the glass side (Position 4). It is not recommended to install it on the opposite side (Position 2).

<p>Medium-sized conference room (between 4m*4m and 6m*6m): height 2.6m, angle 75°.</p>	
<p>Detection Range</p>	
<p>Recommended Installation Location</p>	
<p>Installation Note</p>	<ol style="list-style-type: none"> 1. If there is a display within the detection range, it is recommended to install the device above the display (Position 1). 2. It is recommended to install the device in front of the usual seating position (Position 1). It is not recommended to install it behind the seating position (Position 5). 3. Avoid installing the device in the corners of the conference room (Positions 2/4/7). 4. It is not recommended to install the device on the walls along the usual walking paths. If there is no other option, please adjust the angle to 60° (Positions 5/6). 5. If one side of the conference room is made of glass, please install the device on the glass side (Position 6). It is not recommended to install it on the opposite side (Position 3).

For large meeting rooms (area $\geq 6\text{m} \times 6\text{m}$): for any requirements, please contact a pre-sales or sales representative to arrange a solution evaluation.

Installation Steps:

Step 1: Take out the bracket adhesive, peel off the protective film on one side, and affix it to the magnetic bracket.

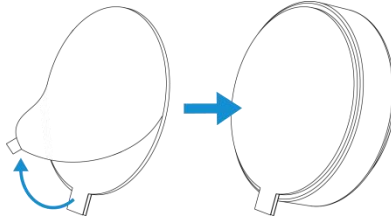

Step 2: After determining the installation position, peel off the protective film on the other side of the bracket adhesive and secure the magnetic bracket to the wall.

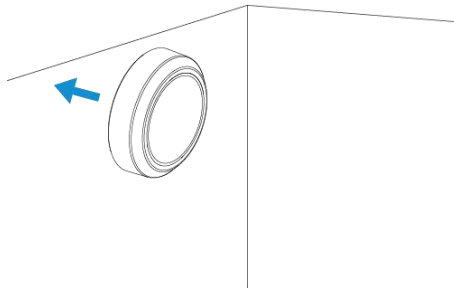

Step 3: Attach the sensor unit to the magnetic bracket.

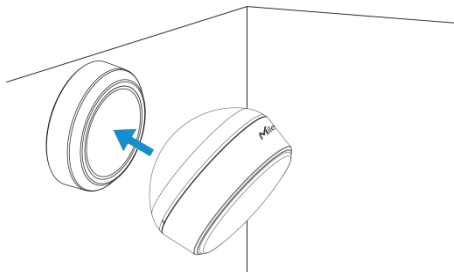

Note: Ensure the sensor logo faces upward during installation.

Step 4: Installation complete.

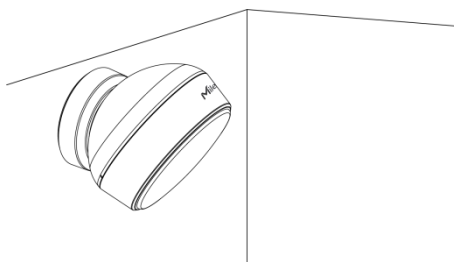
**Installation Note:**

- Ensure the installation surface is flat and stable to prevent the device from tilting or being

unstable.

- Avoid prolonged direct sunlight exposure on the device.
- Ensure that the lens of the device is facing the detection area directly, and avoid any obstructions around it.
- Interference sources such as fans, curtains, and plants can affect the radar's performance. Please try to avoid having these interference sources within the detection range.

5.3 Factors Affecting Accuracy

- Interference sources such as fans, curtains, and plants within the detection range can cause false alarms.
- Continuous presence of people outside the glass surfaces can cause false alarms.
- The device has blind spots; targets within these blind spots cannot be detected.
- Because radar can penetrate objects and has a wide FOV, it is recommended to keep the conference room's door closed after use.
- Because of the radar's wide field of view (FOV), the device is unsuitable for application in small areas like bathrooms.
- This product cannot detect a relatively stationary human body that shows only respiration and heartbeat without any noticeable limb movements.

6. Communication Protocol

All the data is based on the following format (HEX), the Data field should follow the little-endian:

Channel1	Type1	Data1	Channel2	Type2	Data2	Channel 3	...
1 Byte	1 Byte	N Bytes	1 Byte	1 Byte	M Bytes	1 Byte	...

For decoder examples please find files on <https://github.com/Milesight-IoT/SensorDecoders>.

6.1 Basic Information

VS370 sensor reports basic information whenever it joins the network.

Channel	Type	Byte	Description
ff	0b (Power On)	1	ff
	01(Protocol Version)	1	01=>V1
	ff (TSL Version)	2	0100
	16 (Device SN)	8	16 digits
	09 (Hardware Version)	2	01 00 => V1.0
	0a (Firmware Version)	2	01 14 => V1.14
	0f (Device Type)	1	00: Class A

	fe (Reset Report)	1	ff, only report after reset to factory default
--	-------------------	---	--

Example:

ff0bff ff0101 ffff0100 ff166773e33523300001 ff090100 ff0a0101 ff0f00 fffeff					
Channel	Type	Value	Channel	Type	Value
ff	0b (Power On)	ff (Reserved)	ff	01 (Protocol Version)	01 (V1)
Channel	Type	Value	Channel	Type	Value
ff	ff (TSL Version)	0100 (V1.0)	ff	16 (Device SN)	6773e33 5233000 01
Channel	Type	Value	Channel	Type	Value
ff	09 (Hardware Version)	0100 (V1.0)	ff	0a (Firmware Version)	0101 (V1.1)
Channel	Type	Value	Channel	Type	Value
ff	0f (Device Type)	00 (Class A)	ff	fe (Reset Report)	ff

6.2 Sensor Data

Channel	Type	Byte	Description
01	75(Battery Level)	1	UINT8, Unit: %, [1-100]
03	00(Occupied status)	1	01: Occupied; 00: Vacant
04	00(Illumination Status)	1	01: Bright; 00: Dim; fe: Disabled

Examples:

1. Periodic packet:

017564 030001 040000					
Channel	Type	Value	Channel	Type	Value
01	75 (Battery Level)	64=>100%	03	00(Occupied status)	01 => Occupied
Channel	Type	Value			
04	00(Illumination Status)	00=> Dim			

2. Occupancy Status Alarm packet:

030001 040000					
Channel	Type	Value	Channel	Type	Value
03	00(Occupied status)	01 => Occupied	04	00(Illumination Status)	00=> Dim

6.3 Downlink Commands

VS370 supports downlink commands to configure the device. The application port is 85 by default.

Channel	Type	Byte	Description
ff	10(Reboot)	1	ff
	8e(Reporting Interval)	3	<ul style="list-style-type: none"> ● Byte 1: 01 ● Byte 2-3: Reporting Interval, INT16, Unit: min
f9	3e(Occupancy Trigger Sensitivity)	1	00: Low 01: Middle 02: High
	3f(Occupancy Maintaining Sensitivity)	1	00: Low 01: Middle 02: High
	44(Hibernate Period)	1	<ul style="list-style-type: none"> ● Byte 1: 01-Period 1, 00-Period 2 ● Byte 2: 01: enable; 00: disable ● Byte 3-4: Start Time, unit: min ● Byte 5-6 End Time, unit: min
ff	bd(UTC Time Zone)	2	INT16/60
	ba(Daylight Saving Time)	10	<ul style="list-style-type: none"> ● Byte1: 01-Enable; 00-Disable ● Byte2: DST Bias, INT8, Unit:min ● Byte3: Start Month ● Byte4: <ul style="list-style-type: none"> ➢ Bit 7-4: Start Week ➢ Bit 3-0: Start Day ● Byte5-6: Start Time, UINT 16, Unit:min ● Byte7: End Month ● Byte8: <ul style="list-style-type: none"> ➢ Bit 7-4:End Week

			<ul style="list-style-type: none"> ➤ Bit 3-0: End Day ● Byte9-10: End Time, UINT 16, Unit:min
f9	40(Report Vacancy Time)	1	UINT8, Unit: min
	41(Illuminance)	5	<ul style="list-style-type: none"> ● Byte 1: 01-enable, 00-disable ● Byte 2-3: Bright Status Illuminance, UINT 16, unit: lux, Default: 700 ● Byte 4-5: Dim Status Illuminance, UINT 16, unit: lux, Default: 300
ff	84(Milesight D2D Feature)	1	01-enable, 00-disable
	35(Milesight D2D Key)	8	First 16 digits, last 16 digits are fixed as 0
	96(Milesight D2D Settings)	8	<ul style="list-style-type: none"> ● Byte 1: <ul style="list-style-type: none"> 00-Occupied 01-Vacant 02-Bright 03-Dim 04-Occupied/Bright 05-Occupied/Dim ● Byte 2: 01-enable, 00-disable ● Byte 3: 01-enable LoRa Uplink, 00-disable LoRa Uplink ● Byte 4-5: D2D control command ● Byte 6-7: control time, Unit: min ● Byte 8: 01-enable control time, 00-disable control time
	4a(Time Synchronization)	1	ff
	8f(Bluetooth)	1	01: enable; 00: disable

Examples:

1. Reboot the device.

ff10ff		
Channel	Type	Value
ff	10 (Reboot)	ff

2. Set reporting interval as 2 minutes.

ff8e 00 0200		
Channel	Type	Value

ff	8e (Reporting Interval)	02 00=>00 02=>2 mins
----	-------------------------	----------------------

3. Set up Hibernate Mode.

f944 00 01 fe01 ec04		
Channel	Type	Value
f9	44 (Hibernate Mode)	00: Period 1 01: Enable Hibernate mode fe 01 => 01 fe = 510 minutes = 8 hours +30mins = 8:30 ec 04 => 04 ec = 1260minutes =21 hours = 21:00

4. Set time zone as UTC-4.

ffbd 10ff		
Channel	Type	Value
ff	bd(UTC Time Zone)	10 ff => ff10 = -240/60 = -4

5. Set Daylight Saving Time from Mar. /2nd /Sun. 14:00 to Nov. /1st /Mon 14:00 and Bias as 60min.

ffba 01 3c 03 27 4803 0b 11 4803		
Channel	Type	Value
ff	ba(Daylight Saving Time)	01=enable Bias: 3c=60min Start Month: 03=March 27=>0010 0111 Start Week: 0010=2= 2 nd Start Day: 0111=7=Sunday Start Time: 48 03=> 03 48=>840min=14:00 End Month: 0b=11=Nov. 11=>0001 0001 End Week: 0001=1=1 st End Day: 0001=1=Monday End Time: 48 03=> 03 48=>840min=14:00

6. Set D2D Key as 5572404C696E6B4C0000000000000000.

ff35 5572404C696E6B4C		
Channel	Type	Value
ff	35 (Set D2D Key)	5572404C696E6B4C

7. Set D2D settings.

ff96 04 01 01 04e0 0500 01		
Channel	Type	Value

ff	96 (D2D Settings)	04=> Occupied/Bright; 01=>Enable; 01=>Enable LoRa Uplink; 04 e0=>e0 04, Control Command is e0 04; 05 00=>00 05, Control time is 5 mins; 01=>Enable Control Time
----	-------------------	--

8. Enable Illuminance collection and set bright/dim status threshold values.

f941 01 2003 9001		
Channel	Type	Value
f9	41 (Illuminance)	01=>Enable; Max Illuminance: 20 03=>03 20=>800 lux Min Illuminance: 90 01=>01 90=>400 lux

-END-