



Temperature Sensor

Featuring LoRaWAN®

TS201

User Guide



Safety Precautions

Milesight will not shoulder responsibility for any loss or damage resulting from not following the instructions of this operating guide.

- ❖ The device must not be disassembled or remodeled in any way.
- ❖ To ensure the security of your device, please change the device password during the initial configuration. The default password is 123456.
- ❖ The device is not intended to be used as a reference sensor, and Milesight will not should responsibility for any damage which may result from inaccurate readings.
- ❖ Do not place the device close to objects with naked flames.
- ❖ Do not place the device where the temperature is below/above the operating range.
- ❖ Make sure electronic components do not drop out of the enclosure while opening.
- ❖ When installing the battery, please install it accurately, and do not install the inverse or wrong model.
- ❖ The device must never be subjected to shocks or impacts.

Declaration of Conformity

TS201 conforms with the essential requirements and other relevant provisions of the CE, FCC, and RoHS.



Copyright © 2011-2024 Milesight. All rights reserved.

All information in this guide is protected by copyright law. Whereby, no organization or individual shall copy or reproduce the whole or part of this user guide by any means without written authorization from Xiamen Milesight IoT Co., Ltd.

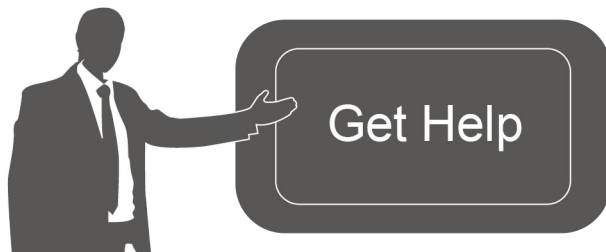

For assistance, please contact

Milesight technical support:

Email: iot.support@milesight.com

Support Portal: support.milesight-iot.com

Tel: 86-592-5085280

Fax: 86-592-5023065

Address: Building C09, Software Park III,
Xiamen 361024, China

Revision History

Date	Doc Version	Description
May 30, 2024	V1.0	Initial version

Contents

1. Product Introduction	5
1.1 Overview	5
1.2 Features	5
2. Hardware Introduction	5
2.1 Packing List	5
2.2 Hardware Overview	6
2.3 Dimensions (mm)	6
3. Battery Installation	6
4. Operation Guide	7
4.1 NFC Configuration	7
4.2 LoRaWAN Settings	7
4.3 Basic Settings	10
4.4 Advanced Settings	11
4.4.1 Calibration Settings	11
4.4.2 Threshold Settings	12
4.4.3 Data Storage	13
4.4.4 Data Retransmission	14
4.5 Maintenance	15
4.5.1 Upgrade	15
4.5.2 Backup	16
4.5.3 Reset to Factory Default	17
5. Installation	18
5.1 Device Installation	18
5.2 Thermal Buffer Bottle	18
6. Communication Protocol	19
6.1 Basic Information	19
6.2 Sensor Data	20
6.3 Downlink Commands	21
6.4 Historical Data Enquiry	23

1. Product Introduction

1.1 Overview

Milesight TS201 is a compact temperature sensor. It is equipped with high-precision sensors and an IP67 waterproof design, making it applicable for accurate temperature data detection in various harsh environments. With the low power consumption technology, TS201 can maintain a long operational life with its internal battery. Combining with Milesight LoRaWAN[®] gateway and Milesight IoT Cloud solution, users can manage all sensor data remotely and visually.

TS201 is widely used for temperature monitoring applications like food processing, cold chain storage of food or medicine, etc.

1.2 Features

- Provide highly accurate and stable DS18B20 temperature sensor probe with high-resolution.
- Temperature probe is detachable for self-calibration.
- IP67 waterproof with specialized battery compartment design , making it suitable for harsh environment.
- Flexible design for various mounting options.
- Store up to 2800 historical records locally and support retransmission to prevent data loss.
- Equipped with NFC and Type-C USB for quick and easy configuration.
- Function effectively with standard LoRaWAN[®] gateways and network servers.
- Compatible with Milesight IoT Cloud.

2. Hardware Introduction

2.1 Packing List



1 x TS201 Device

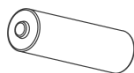

1 x ER14505 Li-SOCl₂
Battery



1 x Temperature Probe

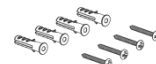

4 x Wall Screw
Mounting Kits



1 x Warranty Card



1 x Quick Start Guide



1 x Glass Bead Thermal
Buffer Bottle Kit (Optional)



If any of the above items is missing or damaged, please contact your sales representative.

2.2 Hardware Overview

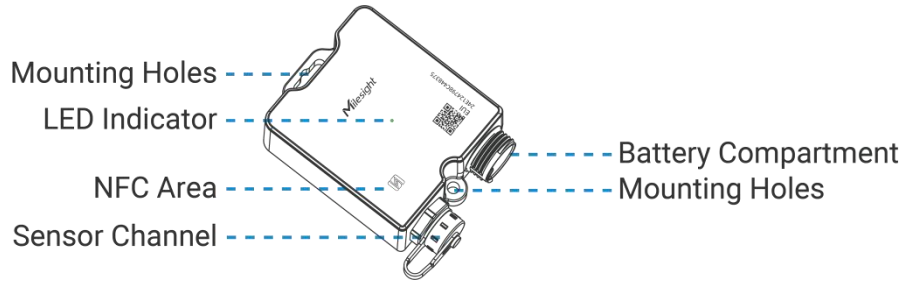

2.3 Dimensions (mm)

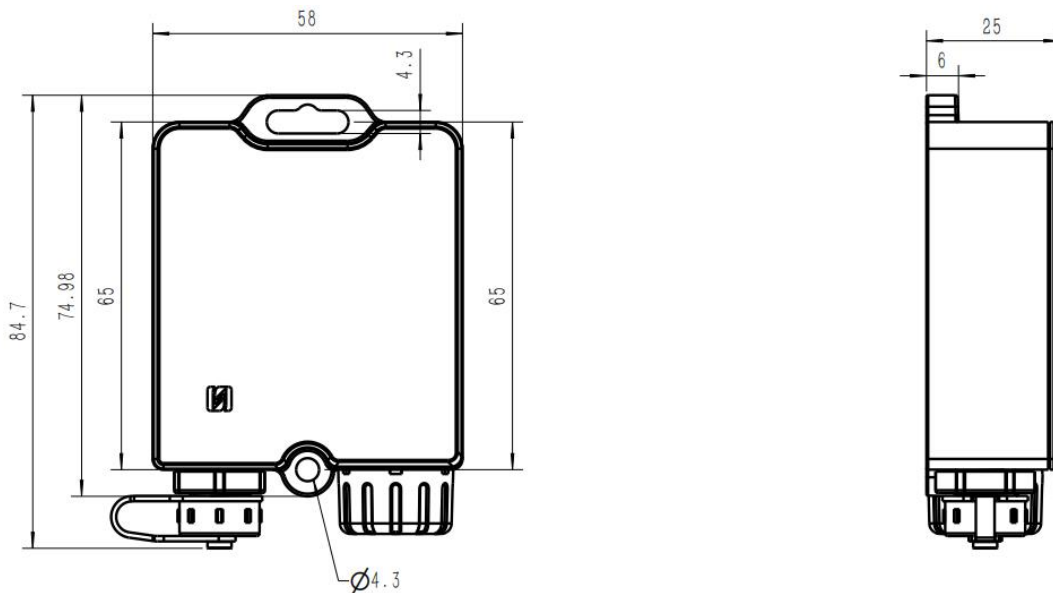

3. Battery Installation

Note: The temperature probe should be installed before the battery is inserted.

Insert the battery and tighten the battery compartment cover. The device will turn on automatically and the LED indicator will turn on for 3s.

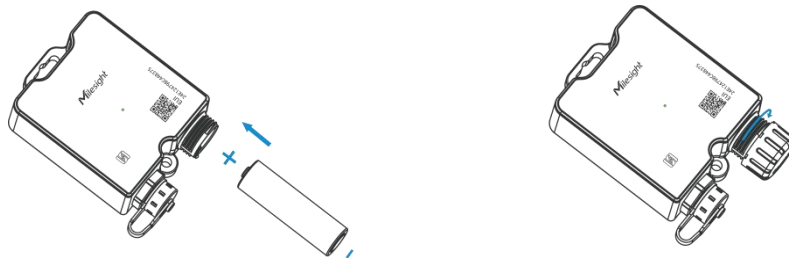

4. Operation Guide

4.1 NFC Configuration

1. Download and install “Milesight ToolBox” App on an NFC-supported smart phone.
2. Open “Milesight ToolBox” App and attach the NFC area of the smart phone to the device. Click “NFC Read” to read the device and click “Write” to configure the device settings. It’s suggested to change the default password for security reasons. (Default password: 123456).



Note:

- 1) Ensure the location of the smartphone NFC area and it’s recommended to take off the phone case.
- 2) If the smartphone fails to read/write configurations via NFC, move it away and try again later.

4.2 LoRaWAN Settings

Go to **Device > Settings > LoRaWAN® Settings** of ToolBox App to configure AppEUI, Join Type, Application Key and other information. You can also keep all settings by default.

LoRaWAN Settings 

Device EUI

24E124809E080562

* APP EUI

24e124c0002a0001

* Application Port

85

LoRaWAN Version

V1.0.3 

Work Mode

Class A Confirmed Mode 

Join Type

OTAA 

* Application Key

Rejoin Mode Set the number of detection signals sent 

32

Parameters	Description
Device EUI	The device's unique ID that can be found on the label.
App EUI	The default App EUI is 24E124C0002A0001.
Application Port	The port used for sending and receiving data, the default port is 85.
LoRaWAN Version	V1.0.2 and V1.0.3 are available.
Work Mode	It is fixed as Class A.
Confirmed Mode	If the device does not receive an ACK packet from the network server, it will resend data once.

Join Type	OTAA and ABP modes are available.
Application Key	Appkey for OTAA mode, the default is: 5572404C696E6B4C6F52613230313823.
Rejoin Mode	<p>Reporting interval \leq 35 mins: the device will send a specific number of LinkCheckReq MAC packets to the network server every reporting interval or every double reporting interval to validate connectivity; If there is no response, the device will re-join the network.</p> <p>Reporting interval $>$ 35 mins: the device will send a specific number of LinkCheckReq MAC packets to the network server every reporting interval to validate connectivity; If there is no response, the device will re-join the network.</p> <p>Note: Only OTAA mode supports rejoin mode.</p>
Set the number of packets sent	<p>When rejoin mode is enabled, set the number of LinkCheckReq packets will be sent.</p> <p>Note: The actual sending number is Set the number of packet sent + 1.</p>
Device Address	DevAddr for ABP mode, default is the 5th to 12th digits of SN.
Network Session Key	Nwkskey for ABP mode, default is 5572404C696E6B4C6F52613230313823.
Application Session Key	Appskey for ABP mode, default is 5572404C696E6B4C6F52613230313823.
Supported Frequency	<p>Select supported frequency and select channels to send uplinks.</p> <p>Note: Make sure the channels match the LoRaWAN[®] gateway.</p>
Channel Index	<p>If frequency is set to CN470, AU915 or US915, you can enter the index of the channel you wish to enable in the input box, and separate them separated with commas.</p> <p>Examples:</p> <p>1, 40: Enabling Channel 1 and Channel 40</p> <p>1-40: Enabling Channel 1 to Channel 40</p> <p>1-40, 60: Enabling Channel 1 to Channel 40 and Channel 60</p> <p>All: Enabling all channels</p> <p>Null: Indicates that all channels are disabled</p>

	<p>* Support Frequency</p> <p>AU915</p> <p>Enable Channel Index ⓘ</p> <p>0-71</p> <table border="1"> <thead> <tr> <th>Index</th> <th>Frequency/MHz ⓘ</th> </tr> </thead> <tbody> <tr> <td>0 - 15</td> <td>915.2 - 918.2</td> </tr> <tr> <td>16 - 31</td> <td>918.4 - 921.4</td> </tr> <tr> <td>32 - 47</td> <td>921.6 - 924.6</td> </tr> <tr> <td>48 - 63</td> <td>924.8 - 927.8</td> </tr> <tr> <td>64 - 71</td> <td>915.9 - 927.1</td> </tr> </tbody> </table>	Index	Frequency/MHz ⓘ	0 - 15	915.2 - 918.2	16 - 31	918.4 - 921.4	32 - 47	921.6 - 924.6	48 - 63	924.8 - 927.8	64 - 71	915.9 - 927.1
Index	Frequency/MHz ⓘ												
0 - 15	915.2 - 918.2												
16 - 31	918.4 - 921.4												
32 - 47	921.6 - 924.6												
48 - 63	924.8 - 927.8												
64 - 71	915.9 - 927.1												
ADR Mode	Allow the network server to adjust data rate of the device. This only works with Standard Channel Mode.												
Spread Factor	If ADR is disabled, the device will send data via this spread factor.												
TXPower	Transmit power of the device.												
RX2 Data Rate	RX2 data rate to receive downlinks.												
RX2 Frequency	RX2 frequency to receive downlinks. Unit: Hz												

Note:

- 1) Please contact sales for the device EUI list if there are many units.
- 2) Please contact sales if you need random App keys before purchase.
- 3) Select OTAA mode if you use Milesight IoT Cloud to manage devices.

4.3 Basic Settings

General Settings ^

Reporting Interval(min)

2

Temperature Unit

°C

Data Storage ⓘ

Data Retransmission ⓘ

Change Password

Parameters	Description
Reporting Interval	Reporting interval of transmitting data to the network server. Range: 1~1440min; Default: 10min
Temperature Unit	Change the temperature unit displayed on the ToolBox. Note: 1) The temperature reported by the device is mainly the value of °C. 2) After changing the temperature unit, it is necessary to modify the value of relevant threshold settings.
Data Storage	Start or stop reporting data storage locally.
Data Retransmission	Start or stop data retransmission.
Change Password	Change the password for ToolBox app to write this device.

4.4 Advanced Settings

4.4.1 Calibration Settings

ToolBox supports temperature calibration. Type the calibration value and save, the device will add the calibration to raw value, then display and report the final value.

Calibration Settings ^

Temperature

Current Value(°C)

26

Final Value(°C)

26

Calibration Value(°C)

0

4.4.2 Threshold Settings

TS201 can set temperature threshold alarms, temperature change alarms and so on. Enable the threshold settings and enter the threshold. TS201 sensor will upload the current data instantly when the alarm is triggered. Note that when you change the temperature unit, please re-configure the threshold.

Parameters	Description
Temperature Threshold	When the temperature is over or below the threshold value, the device will report an alarm packet.
Temperature change greater than	When this function is enabled, the device will report an alarm packet when the absolute value of the difference between the two collected values exceeds the set threshold.
Collecting Interval	Set the interval of collecting data and reporting alarm, the default interval is 1min.
Alarm Reporting Times	Set the times of alarm report, the default is 1 time.
Alarm Dismiss Report	After it is enabled, when the collected value changes from exceeding the threshold range to not exceeding the threshold range, an alarm dismiss packet will be reported.

4.4.3 Data Storage

TS201 sensor supports storing more than 2800 data records locally and exporting data via ToolBox App. The device will record the data according to the reporting interval even not joining to network.

Here are the steps for storage:

1. Ensure the device time is correct, click **Sync** to sync the time.

Device Status	ON
Reading Mode	NFC
Battery	99%
Temperature	26.0°C
Device Time	2024-05-21 10:10 Sync

2. Enable **Data Storage** feature.

General Settings ^

Reporting Interval(min)

Temperature Unit

Data Storage ⓘ

3. Click **Export Historical Data**, then select the data period and click **Confirm** to export data. The maximum export data period on ToolBox App is 14 days.

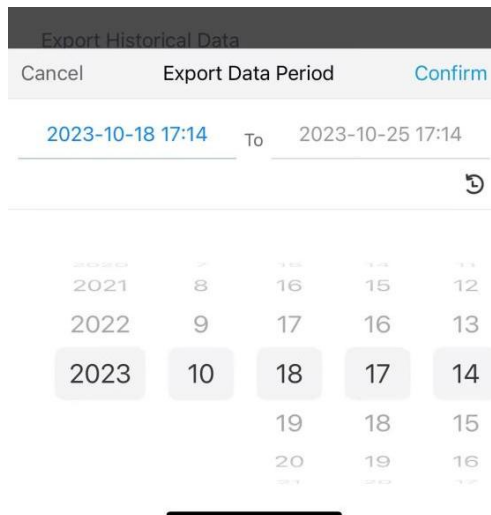

4.4.4 Data Retransmission

TS201 sensor supports data retransmission to ensure the network server can get all data even if the network is down for some time. There are two ways to get the lost data:

- Network server sends downlink commands to enquire the historical data for specifying time range, refer to section [Historical Data Enquiry](#).
- When the network is down if no response from LinkCheckReq MAC packets for a period of time, the device will record the network disconnected time and re-transmit the lost data after the device re-connects the network.

Here are the steps for retransmission:

1. Ensure the device time is correct, please click **Sync** to sync the time.

Device Status	ON
Reading Mode	NFC
Battery	99%
Temperature	26.0°C
Device Time	2024-05-21 10:10
	Sync

2. Enable **Data Storage** and **Data Retransmission** feature.

General Settings ^

Reporting Interval(min)

2

Temperature Unit

°C

Data Storage ⓘ

Data Retransmission ⓘ

3. Go to **Device > Setting > LoRaWAN Settings** to enable rejoin mode and set the number of packets sent. For example, the device will send LinkCheckReq MAC packets to the network server regularly to check any network disconnection; if there is no response for 32+1 times, the join status will change to de-activated and the device will record a data lost time point (the time it reconnected to the network).

Rejoin Mode

Set the number of detection signals sent ⓘ

32

4. After the network connection is restored, the device will send the lost data from the point in time when the data was lost according to the data retransmission interval (600s by default).

Note:

- 1) If the device is rebooted or re-powered when data retransmission is not completed, the interrupted retransmission data will be retransmitted first after the network is reconnected to the network, and then the newly triggered retransmission data will be transmitted.
- 2) If the network is disconnected again during data retransmission, it will only send the latest disconnection data.
- 3) The retransmission data format is started with "20ce", please refer to section [Historical Data Enquiry](#).
- 4) Data retransmission will increase the uplinks and shorten the battery life.

4.5 Maintenance

4.5.1 Upgrade

1. Download firmware from Milesight website to your smartphone or computer.

2. Click **Browse** to import firmware, and click **Upgrade** to upgrade the device.

Note:

- 1) Operation on ToolBox is not supported during a firmware upgrade.
- 2) Only the Android version of ToolBox App supports the upgrade feature.

Firmware Version	V1.1
Hardware Version	V1.0
Manual Upgrade	

[Browse](#)

4.5.2 Backup

TS201 supports configuring backup setting for easy and quick device configuration in bulk. Backup is allowed only for devices with the same model and LoRaWAN® frequency band.

1. Go to **Template** page on the App and save the current settings as a template. You can also edit the template file.
2. Select one template file saved in the smartphone and click **Write**, then attach the smartphone to another device to write the configuration.

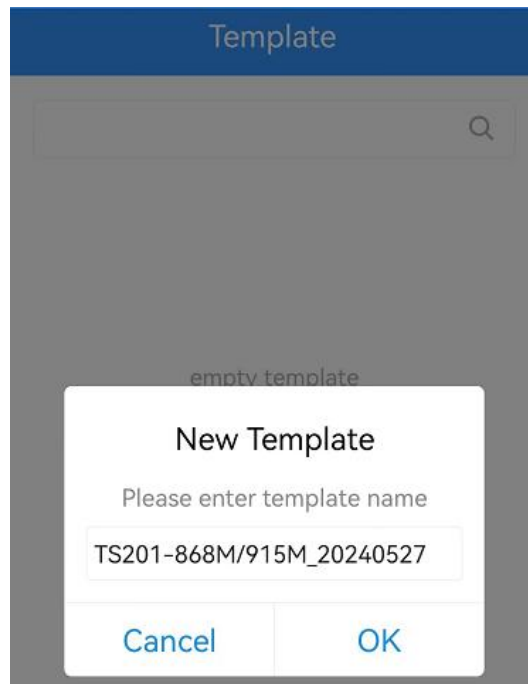

Note: Slide the template item left to edit or delete the template. Click the template to edit the configurations.

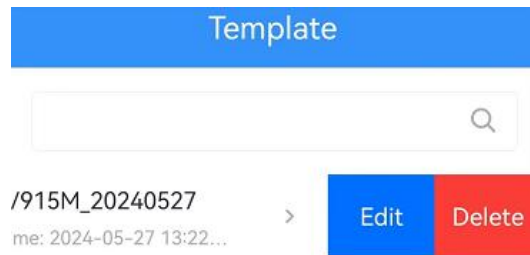

4.5.3 Reset to Factory Default

Go to **Device** > **Maintenance** to click **Restore Factory Settings** button, then attach the smartphone with NFC area to the device to complete the reset.

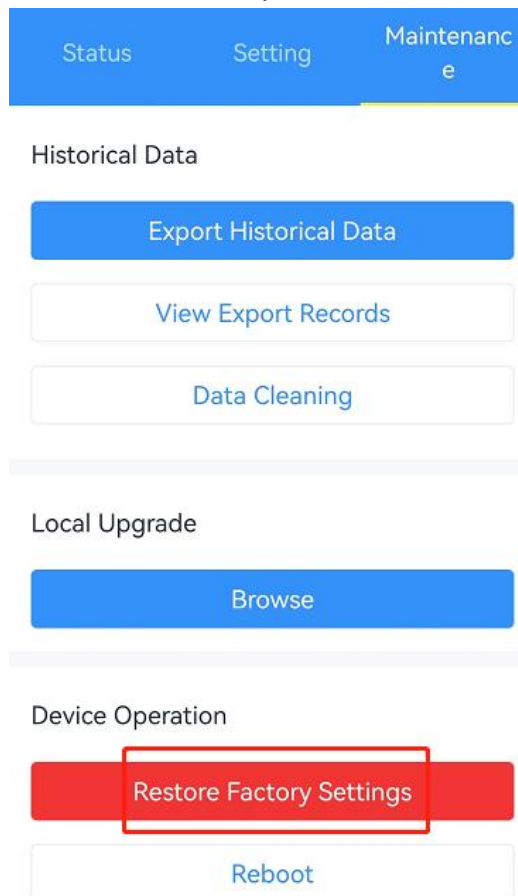

Note: Reset operation will not clean the stored data, please click Data Cleaning or Clear button to clear data if necessary.

Historical Data

[Export Historical Data](#)[View Export Records](#)[Data Cleaning](#)

5. Installation

5.1 Device Installation

- **Wall Screw Mounting:**

1. Fix the wall plugs to a flat surface according to the device mounting holes, then secure the device to the wall plugs using screws.
2. Cover the screws with cover caps.

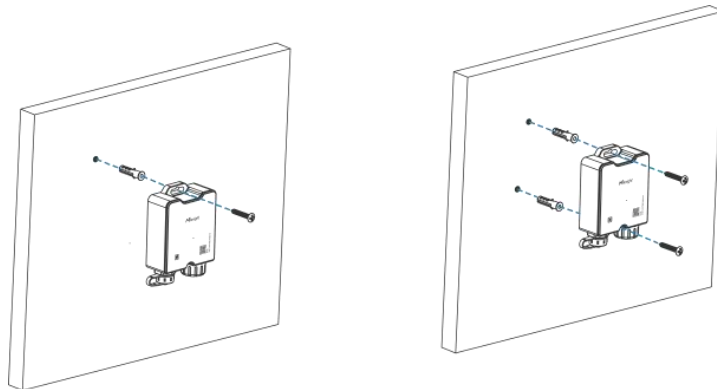

- **Cable-tie Mounting:**

Pass a cable tie through the gap behind the device and wrap it to the pole.

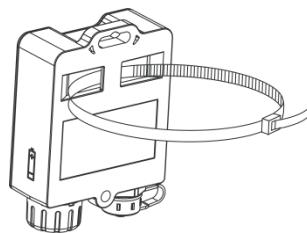

5.2 Thermal Buffer Bottle

It is necessary to unplug the stopper inside the bottle cap, then restore the cap and insert the temperature probe into the bottle. When using, it can be placed to places like freezers and refrigerators to ensure more accurate temperature measurement.

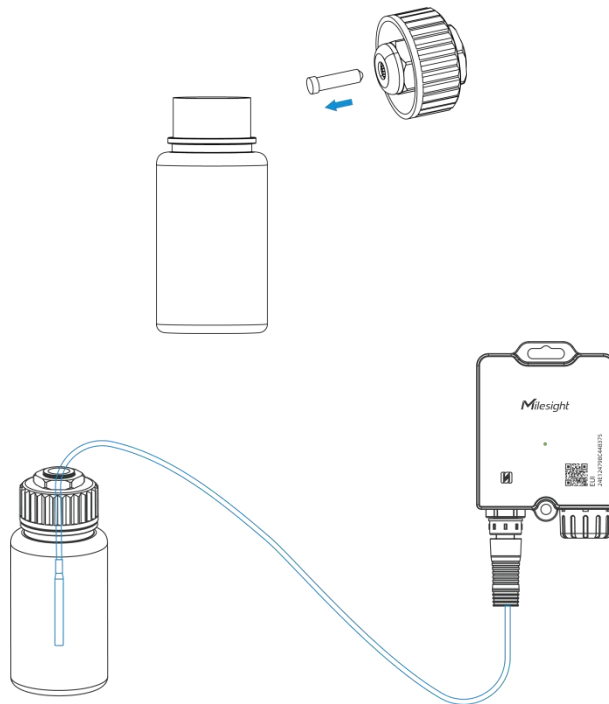

6. Communication Protocol

All data are based on the following format (HEX), the Data field should follow little-endian:

Channel1	Type1	Data1	Channel2	Type2	Data2	Channel 3	...
1 Byte	1 Byte	N Bytes	1 Byte	1 Byte	M Bytes	1 Byte	...

For decoder examples please find files on <https://github.com/Milesight-IoT/SensorDecoders>.

6.1 Basic Information

Channel	Type	Byte	Value
ff	0b (Power On)	1	ff
	01 (Protocol Version)	1	11 => V1.1
	ff (TSL Version)	2	0101 => V1.1
	16 (Device SN)	8	16 digits
	09 (Hardware Version)	2	0110 => V1.1
	0a (Firmware Version)	2	0101 => V1.1
	0f (Device Type)	1	00: Class A

Example:

ff0bff ff0101 ffff0100 ff166809e08056200001 ff090100 ff0a0101 ff0f00					
Channel	Type	Value	Channel	Type	Value
ff	0b (Power On)	ff (Reserved)	ff	01 (Protocol Version)	01 (V1)

Channel	Type	Value	Channel	Type	Value
ff	ff (TSL Version)	0100 (V1.0)	ff	16 (Device SN)	6809e08056200 001
Channel	Type	Value	Channel	Type	Value
ff	09 (Hardware Version)	0100 (V1.0)	ff	0a (Firmware Version)	0101 (V1.1)
Channel	Type	Value			
ff	0f (Device Type)	00 (Class A)			

6.2 Sensor Data

Channel	Type	Byte	Description
01	75(Battery Level)	1	UINT8, Unit: %, [1-100]
03	67(Temperature)	2	INT16*0.1, Unit: °C
b3	67(Abnormal Report)	1	00-Abnormal collection report 01-Temperature overrange report
83	67(Temperature Threshold Alarm)	3	<ul style="list-style-type: none"> Byte 1-2: Temperature, INT16*0.1, Unit: °C Byte 3: Alarm Status, 00 -Alarm dismiss, 01 -Alarm
93	67(Temperature_change Threshold)	5	<ul style="list-style-type: none"> Byte 1-2: Temperature, INT16*0.1, Unit: °C Byte 3-4: Temperature_change, INT16*0.1, Unit: °C Byte 5: 02

Example:

1. Periodic Packet

017564 03671101					
Channel	Type	Value	Channel	Type	Value
01	75 (Battery)	64 => 100%	03	67 (Temperature)	1101 => 0111 =>273*0.1 =27.3°C

2. Abnormal Report Packet

b367 01		
Channel	Type	Value

b3	67 (Abnormal Report)	01 => Temperature overrange
----	-------------------------	-----------------------------

3. Temperature Threshold Alarm Packet

8367 340101		
Channel	Type	Value
83	67 (Temperature)	34 01 => 01 34 => $308 \times 0.1 = 30.8^{\circ}\text{C}$ 01 => Temperature Threshold Alarm

4. Temperature_change Alarm Packet

93d7 fa00 0700 02		
Channel	Type	Value
93	67	Temperature: fa 00 => 00 fa => $250 \times 0.1 = 25^{\circ}\text{C}$ Temperature_change: 07 00 => 00 07 => $7 \times 0.1 = 0.7^{\circ}\text{C}$ 02 => Temperature_change Alarm

6.3 Downlink Commands

TS201 supports downlink commands to configure the device. The application port is 85 by default.

Channel	Type	Byte	Description
ff	10 (Reboot)	1	ff
	8e (Reporting Interval)	3	<ul style="list-style-type: none"> Byte 1: 00 Byte 2-3: reporting interval, INT16, Unit: min
	02 (Collecting Interval)	2	Unit: s
	f2(Alarm Reporting Times)	2	range: 1~1000
	f5(Alarm Dismiss Report)	1	01-enable; 00-disable
	68 (Data Storage)	1	01-enable; 00-disable
	ea(Temperature Calibration)	3	<ul style="list-style-type: none"> Byte 1: 80-enable; 00-disable Byte 2-3: calibration value, INT16*0.1, Unit: $^{\circ}\text{C}$
f9	0b(Threshold Alarm)	7	<ul style="list-style-type: none"> Byte 1: 01 Byte 2: 01 - below; 02 - over; 03 - within; 04 - below or over Byte 3-4: Max. Temperature,

			INT16*0.1, Unit: °C ● Byte 5-6: Min. Temperature, INT16*0.1, Unit: °C ● Byte 7: 01-enable; 00-disable
	0c(Temperature_change Alarm)	4	● Byte 1: 02 ● Byte 2-3: INT16*0.1, Unit: °C, range: 0.1~100°C ● Byte 4: 01-enable; 00-disable
	0d (Data Retransmission)	3	● Byte 1: 01-enable; 00-disable ● Byte 2-3: interval time, Unit:s, range: 30~1200s (600s by default)

Example:

1. Set reporting interval as 5 minutes.

ff8e 00 0500		
Channel	Type	Value
ff	8e (Set Reporting Interval)	00 => Reserved 05 00 => 00 05 = 5 minutes

2. Set the calibration.

ffea 80 6400		
Channel	Type	Value
ff	ea (Set Calibration)	80 => enable temperature calibration 6400 => 00 64 => 100*0.1 = 10°C

3. Set a temperature threshold alarm as above 37°C.

f90b 01 02 7201 0000 01		
Channel	Type	Value
f9	0b (Set Threshold Alarm)	01 => set threshold alarm 02 => above 72 01=> 01 72 => 370*0.1=37°C 01 => enable threshold alarm

4. Set data retransmission as 100s.

f90d 01 6400		
Channel	Type	Value
f9	0d (Set Data Retransmission)	01 => enable Data Retransmission 6400 => 00 64 => 100s

6.4 Historical Data Enquiry

TS201 supports sending downlink commands to enquire historical data for specified time point or within a certain time range. Before utilizing this feature, it is important to make sure **the device time is correct and data storage feature was enable to store the data.**

Command format:

Channel	Type	Byte	Description
fd	6b (Enquire data in time point)	4	unix timestamp
	6c (Enquire data in time range)	8	<ul style="list-style-type: none"> Byte 1-4: Start time, unix timestamp Byte 5-8: End time, unix timestamp
	6d (Stop query data report)	1	ff
ff	68 (Set Data Storage)	1	01-enable; 00-disable
	27 (Data Cleaning)	1	01

Reply format:

Channel	Type	Byte	Description
fc	6b/6c	1	00: data enquiry success; 01: time point or time range invalid; 02: no data in this time or time range.
20	ce (Historical Data)	7	<ul style="list-style-type: none"> Byte 1-4: Data time stamp Byte 5: <ul style="list-style-type: none"> Bit3~Bit0: <ul style="list-style-type: none"> 0001: Periodic report 0010: Alarm report 0011: Alarm dismiss report Bit7~Bit4: <ul style="list-style-type: none"> 0000: Normal 0001: Collection abnormal 0010: Overrange report Byte 6-7: Data

Note:

1. The device only uploads no more than 300 data records per range inquiry.
2. When enquiring about the data in time point, it will upload the data that is the closest to the search point within the reporting interval range. For example, if the device's reporting interval is 10 minutes and users send a command to search for 17:00's data, if the device finds there is data stored in 17:00, it will upload these data. If not, it will search for data between 16:50 to 17:10 and upload the data which is the closest to 17:00.

Example:

1. Enquire historical data between 2024/5/15 10:20:22 to 2024-5-20 10:20:22.

fd6c e61b4466 66b34a66		
Channel	Type	Value
fd	6c (Enquire data in time range)	Start time: e61b4466 => 66441be6 = 1715739622s =2024/5/15 10:20:22 End time: 66b34a66 => 664ab366 = 1716171622s =2024-5-20 10:20:22

Reply:

fc6c00		
Channel	Type	Value
fc	6c (Enquire data in time range)	00: data enquiry success

20ce e81b4466 01 0a01			
Channel	Type	Time Stamp	Value
20	ce (Historical Data)	e81b4466 => 6644b1e8 = 1715778024s = 2024-5-15 21:00:24	01 => 0000 0001 = Normal +Periodic Report 0a01 => 01 0a => 266*0.1=26.6°C

-----END-----