

# H.265+ Motorized Pro Dome Network Camera



IP67 + IK10

Motorized Lens

DATASHEET

## KEY FEATURES

- ▶ **Smart Stream** (Bandwidth, storage and bit rate are saved with Smart Stream On, eg, H.265+ saves 70%~80% bandwidth that of H.264.)
- ▶ **Smart IR II** (Combining the High Beam and Low Beam to adjust IR intensity to fit different lighting conditions.)
- ▶ **0.001Lux Starlight** (Deliver high detailed color images even in low light environment reaching 0.001Lux.)
- ▶ **140dB Super WDR** (Excellent performance even when the ratio of the luminosity of brightest and darkest is up to 140dB.)
- ▶ **P-Iris** (Giving you a more clear scene with depth of view.)
- ▶ **Advanced Functions** (Boasting to support various advanced functions such as HLC, Defog, ROI.)
- ▶ **SIP** (Session Initiation Protocol. Providing audio/alarm/intercom and video streaming for mobile phones and video phones.)
- ▶ **256G** (Supporting ultra-large external microSD/SDHC/SDXC card storage up to 256G.)

### 30fps@4K

Providing 4K HD resolution with frame rate of 30fps, the camera performs well in catching detailed image regardless of the moving speed.



### 3 in 1 Super WDR Pro - 140dB

Milesight upgraded 3 in 1 Super WDR Pro outputs three frames each line, which is able to bring more details especially moving subjects. What's more, it greatly improves image quality for reducing smear and noisy points. The ratio that the brightest light signal values divided by the darkest light signal values is up to 140dB.

### 120fps

With the industry leading frame rate reaching 120fps, the cameras can easily catch images with no latency despite of the high-speed movement, which is the best choice for the demanding requirements especially for intelligent cameras.

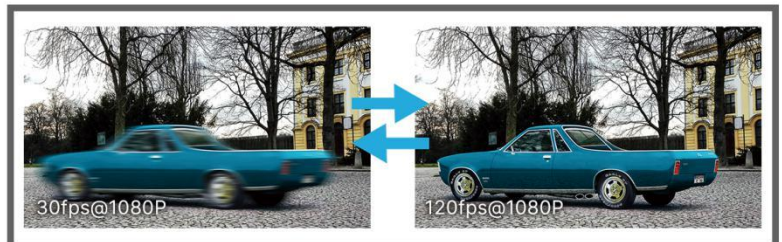

### Clamshell Design

Aiming to reduce the installation troubles to the least, Milesight creatively introduces the clamshell design to the dome base. This revolutionary innovation enlarges the space to make cable connection a piece of cake, greatly saving efforts for installers.

# H.265+ Motorized Pro Dome Network Camera



	Model	MS-C2872-(R)F(I)PB (2MP)	MS-C2972-(Q)(T)(R)F(I)PB (2MP)	MS-C5372-(H)F(I)PB (5MP)
<b>Camera</b>	Image Sensor	1/2" Progressive Scan CMOS	1/2.8" Progressive Scan CMOS	
	Min. Illumination	Color: 0.001Lux@F1.2 Color: 0.002Lux@F1.4 B/W: 0Lux with IR on	Color: 0.002Lux@F1.2 Color: 0.005Lux@F1.4 B/W: 0Lux with IR on	Color: 0.005Lux@F1.2 Color: 0.008Lux@F1.4 B/W: 0Lux with IR on
	WDR	140dB Super WDR	140dB Super WDR <b>(Super WDR Pro is optional for Q &amp; T Series)</b>	120dB Super WDR
	Shutter Time	1/100000s~1s		
	IR Distance	Up to 50m	Up to 50m(3.0~10.5mm/2.7~13.5mm) Up to 90m(7~22mm)	
	Day/Night Mode S/N	Day/Night/Auto/Customize/Schedule >55dB		
	<b>Lens</b>	Lens	Motorized 3.6~10mm@F1.4 P-Iris(Optional)	Motorized 2.7~13.5mm/3.0~10.5mm/7~22mm@F1.4 P-Iris(Optional)
Field of View		H104°~H43°/D120°~D50°/V59°~V24°	H115°~H34°/D135°~D39° /V62°~V19° (2.7~13.5mm) H102°~H34°/D118°~D38° /V56°~V19° (3.0~10.5m) H44°~H17°/D51°~D19° /V24°~V9° (7~22mm)	H100°~H32°/D125°~D40° /V74°~V24° (2.7~13.5mm) H90°~H31°/D114°~D38° /V67°~V23°(3.0~10.5mm) H37°~H15°/D47°~D19° /V28°~V11° (7~22mm)
Mount		Φ14		
Focus Control		Auto/Manual		
Iris Control (Optional for I Series)		Auto/Manual		
<b>Video</b>	Max. Image Resolution	1920x1080		2592x1944
	Primary Stream	60fps@(1920x1080) <b>(Optional for R Series),</b> 30fps@(1920x1080, 1280x960, 1280x720,704x576)	120fps@(1920x1080) <b>(Optional for Q Series),</b> 90fps@(1920x1080) <b>(Optional for T Series),</b> 60fps@(1920x1080) <b>(Optional for R Series),</b> 30fps@(1920x1080, 1280x960, 1280x720,704x576)	30fps@(2592x1944), 45fps@(2048x1536), 60fps@(1920x1080) <b>(Optional for H Series),</b> 20fps@(2592x1944), 30fps@(2048x1536, 1920x1080, 1280x960, 1280x720, 704x576)
	Secondary Stream	30fps@(704x576, 640x480, 640x360, 352x288, 320x240, 320x192, 320x180)		
	Tertiary Stream	30fps@(1920x1080, 1280x720, 704x576, 640x480, 640x360, 320x240, 320x192, 320x180)		
	Video Compression	H.265+/H.265(HEVC)/H.264+/H.264/MJPEG		
	Video Bit Rate	16Kbps~16Mbps(CBR/VBR Adjustable)		
	Privacy Masking	Up to 8 areas		
	ROI	Up to 8 areas		
Image Setting	Brightness/Contrast/Saturation/Sharpness			

# H.265+ Motorized Pro Dome Network Camera



<b>Interface</b>	Ethernet	1*RJ45 10M/100M Ethernet Port	
	Audio I/O	1/1; Built-in Microphone and 1 Audio Output interface(Optional Version)	
	Alarm I/O	1/1	
<b>Network</b>	Network Storage	NAS(Support NFS, SMB/CIFS), ANR	
	Protocol	IPv4/IPv6, ARP, TCP, UDP, RTCP, RTP, RTSP, RTMP, HTTP, HTTPS, DNS, DDNS, DHCP, FTP, NTP, SMTP, SNMP, UPnP, Bonjour, SIP, PPPoE, VLAN, 802.1x, QoS, IGMP, ICMP, SSL	
<b>Audio</b>	Audio Compression	G.711/AAC/G.722/G.726	
	Audio Sampling Rate	8/16/32/44.1/48KHz (44.1KHz is available for all except R & T & Q Series.)	8/16/32/48KHz (32KHz and 48KHz are available for H Series.)
	Audio Bit Rate	16~256kbps	16~96kbps, 16~256kbps(Optional for H Series)
	Two-way Audio	Support	
<b>System</b>	Storage	Support microSD/SDHC/SDXC Card Local Storage, up to 256G	
	Advanced Function	BLC, HLC, 2D DNR, 3D DNR, Defog, AWB, EIS, IP Address Filtering, AGC, Anti-flicker, Corridor Mode, Deblur, Watermark	
	SIP/VoIP Support	Yes, Voice & Video-over-IP	
	Event Trigger	Motion Detection, Network Disconnection, Audio Alarm, External Input, etc.	
	Event Action	FTP Upload, SMTP Upload, SD Card Record, External Output, SIP Phone, HTTP Notification, etc.	
	Video Analysis	Region Entrance, Region Exiting, Advanced Motion Detection, Tamper Detection, Line Crossing, Loitering, Human Detection, People Counting, Object Left, Object Removed	
	System Compatibility	ONVIF Profile G & Q & S & T, API	
<b>General</b>	Working Temperature	-40°C~60°C	
	Working Humidity	0~90%(Non-condensing)	
	Power Supply	PoE (802.3af) / DC 12V±10%	
	Power Consumption	8W MAX 12W MAX (With IR on)	
	Housing	Vandal-proof IK10-rated Metal Housing / Up to IP67-rated for Weather-resistant Performance	
	Weight	1100g	
	Dimensions	Φ143mmX108.4mm	
	Warranty	3/5 Years	

# H.265<sup>+</sup> Motorized Pro Dome Network Camera



	Model	MS-C8172-(H)F(I)PB (4K)	MS-C8272-F(I)PB (4K)
<b>Camera</b>	Image Sensor	1/2.8" Progressive Scan CMOS	1/1.8" Progressive Scan CMOS
	Min. Illumination	Color: 0.01Lux@F1.2 Color: 0.012Lux@F1.4 B/W: 0Lux with IR on	Color: 0.006Lux@F1.2 Color: 0.009Lux@F1.4 B/W: 0Lux with IR on
	WDR	120dB Super WDR	
	Shutter Time	1/100000s~1s	
	IR Distance	Up to 50m	
	Day/Night Mode	Day/Night/Auto/Customize/Schedule	
	S/N	>55dB	
	<b>Lens</b>	Lens	Motorized 2.7~13.5mm@F1.4 P-Iris(Optional)
Field of View		H96°~H33°/D112°~D37°/V53°~V18°	H110°~H46°/D126°~D54°/V61°~V25°
Mount		Ø14	
Focus Control		Auto/Manual	
Iris Control (Optional for I Series)		Auto/Manual	
<b>Video</b>	Max. Image Resolution	3840x2160	
	Primary Stream	<b>30fps@(3840x2160)(Optional for H Series),</b> 15fps@(3840x2160), 30fps@(3072x2048, 2592x1944, 2592x1520, 2048x1536, 1920x1080, 1280x960, 1280x720, 704x576)	30fps@(3840x2160, 3072x2048, 2592x1944, 2592x1520, 2048x1536, 1920x1080, 1280x960, 1280x720, 704x576)
	Secondary Stream	30fps@(704x576, 640x480, 640x360, 352x288, 320x240, 320x192, 320x180)	
	Tertiary Stream	30fps@(1920x1080, 1280x720, 704x576, 640x480, 640x360, 320x240, 320x192, 320x180)	
	Video Compression	H.265 <sup>+</sup> /H.265(HEVC)/H.264 <sup>+</sup> /H.264/MJPEG	
	Video Bit Rate	16Kbps~16Mbps(CBR/VBR Adjustable)	
	Privacy Masking	Up to 8 areas	
	ROI	Up to 8 areas	
	Image Setting	Brightness/Contrast/Saturation/Sharpness	
<b>Interface</b>	Ethernet	1*RJ45 10M/100M Ethernet Port	
	Audio I/O	1/1; Built-in Microphone and 1 Audio Output interface(Optional Version)	
	Alarm I/O	1/1	
<b>Network</b>	Network Storage	NAS(Support NFS, SMB/CIFS), ANR	
	Protocol	IPv4/IPv6, ARP, TCP, UDP, RTCP, RTP, RTSP, RTMP, HTTP, HTTPS, DNS, DDNS, DHCP, FTP, NTP, SMTP, SNMP, UPnP, Bonjour, SIP, PPPoE, VLAN, 802.1x, QoS, IGMP, ICMP, SSL	
<b>Audio</b>	Audio Compression	G.711/AAC/G.722/G.726	
	Audio Sampling Rate	8/16/32/48KHz	
	Audio Bit Rate	16~256kbps	
	Two-way Audio	Support	

# H.265+ Motorized Pro Dome Network Camera



<b>System</b>	Storage	Support microSD/SDHC/SDXC Card Local Storage, up to 256G	
	Advanced Function	BLC, HLC, 2D DNR, 3D DNR, Defog, AWB, EIS, IP Address Filtering, AGC, Anti-flicker, Corridor Mode, Deblur, Watermark	
	SIP/VoIP Support	Yes, Voice & Video-over-IP	
	Event Trigger	Motion Detection, Network Disconnection, Audio Alarm, External Input, etc.	
	Event Action	FTP Upload, SMTP Upload, SD Card Record, External Output, SIP Phone, HTTP Notification, etc.	
	Video Analysis	Region Entrance, Region Exiting, Advanced Motion Detection, Tamper Detection, Line Crossing, Loitering, Human Detection, People Counting, Object Left, Object Removed	
	System Compatibility	ONVIF Profile G & Q & S & T, API	
<b>General</b>	Working Temperature	-40°C~60°C	
	Working Humidity	0~90%(Non-condensing)	
	Power Supply	PoE (802.3af) / DC 12V±10%	
	Power Consumption	5W MAX 8.2W MAX (With IR on)	6.2W MAX 9.4W MAX (With IR on)
	Weather Proof	Up to IP67-rated for Weather-resistant Performance	
	Housing	Vandal-proof IK10-rated Metal Housing	
	Weight	1100g	
	Dimensions	Φ143mmX108.4mm	
	Warranty	3/5 Years	

# H.265+ Motorized Pro Dome Network Camera



## Structure Diagrams

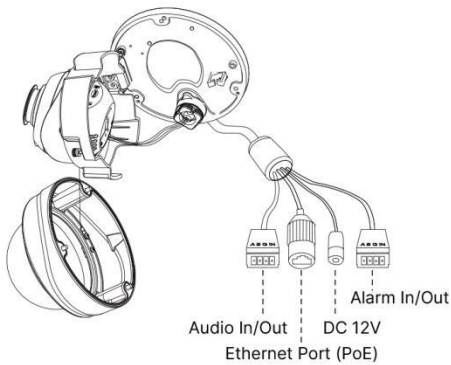

(Default Version)

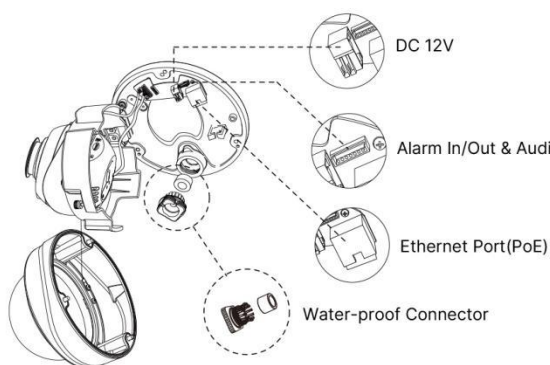

(Optional Version)

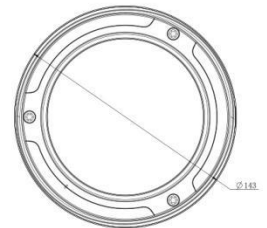
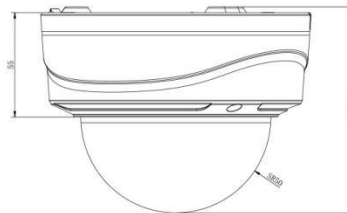
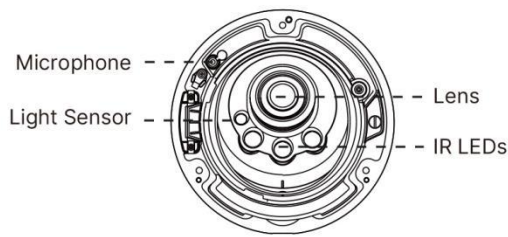
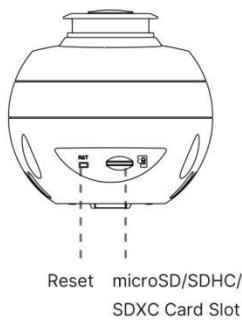
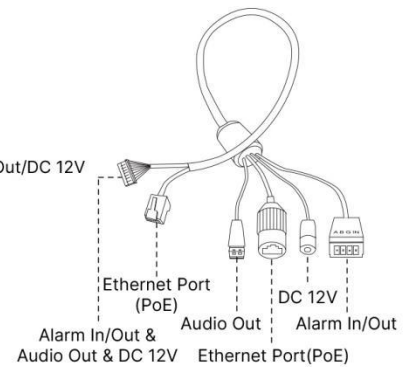

Units: mm

## Accessories Support

### A01 Pole Mount

Weight: 720g  
Dimensions: 170\*51.5\*152.6mm



### A03 External Corner Bracket

Weight: 900g  
Dimensions: 170\*152.5\*76.3mm



### A72 Wall Mount

Weight: 560g  
Dimensions: 240\*160\*136mm



### AC-72 Smoked Dome Cover

For concealing where a camera is pointed



### A75 Junction Box

Weight: 200g  
Dimensions: 145\*167\*33.5mm



### A76 Pendant Mount

Weight: 620g  
Dimensions: 136\*L (L is default as 300mm, also can be extended with A76-L)



### A76-L Extension Lever

Weight: 315g  
Dimensions: 34\*300mm



### A78 Recessed Mount

Weight: 715g  
Dimensions: 256\*256\*94mm



Milesight Technology Co., Ltd. | [www.milesight.com](http://www.milesight.com)

Contact Us: [sales@milesight.com](mailto:sales@milesight.com) [support@milesight.com](mailto:support@milesight.com)

Add: 220 NE 51st Street, Oakland Park, Florida 33334, USA  
Tel: +1-800-561-0485

Add: 925, Anyang SK V1 Center, LS -ro 116beon-gil, Dongan-gu, Anyang-si, Korea  
Tel: +82-31-990-7732

Add: No.23 Wanghai Road, 2nd Software Park, Xiamen, China  
Tel: +86-592-5922772

