



# Industrial LoRaWAN<sup>®</sup> Gateway

## UG56

Quick Guide



## Safety Precautions

Milesight will not shoulder responsibility for any loss or damage resulting from not following the instructions of this operating guide.

- The device must not be modeled in any way.
- Do not place the device close to objects with naked flames.
- Do not place the device where the temperature is below/above the operating range.
- Do not power on the device or connect it to another electrical device when installing.
- Check lightning and water protection when used outdoors.
- Do not connect or power the equipment using cables that have been damaged.

## Related Documents

This Quick Start Guide only explains the installation of Milesight UG56 LoRaWAN® Gateway. For more functionality and advanced settings, please refer to the relevant documents as below.

Document	Description
UG56 Datasheet	Datasheet for UG56 LoRaWAN® Gateway.
UG56 User Guide	Users can refer to the guide for instruction on how to log in the web GUI, and how to configure all the settings.

The related documents are available on Milesight website: <https://www.milesight-iot.com>

## Declaration of Conformity

UG56 is in conformity with the essential requirements and other relevant provisions of the CE, FCC, and RoHS.

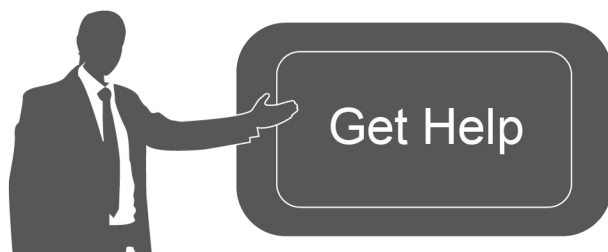

For assistance, please contact  
Milesight technical support:  
Email: [iot.support@milesight.com](mailto:iot.support@milesight.com)  
Tel: 86-592-5085280  
Fax: 86-592-5023065

## Revision History

Date	Doc Version	Description
Aug.8, 2022	V1.0	Initial version

# Contents

1. Packing List .....	4
2. Hardware Introduction .....	4
2.1 Overview .....	4
2.3 LED Indicators .....	5
2.4 Reset Button .....	5
3. Hardware Installation .....	6
3.1 SIM & Micro SD Installation .....	6
3.2 Antenna Installation .....	6
3.3 Power Supply .....	7
3.4 Gateway Installation .....	7
4. Web GUI Access .....	9
4.1 Wireless Access .....	9
4.2 Wired Access .....	10
5. Network Connection .....	13
5.1 Configure the Ethernet Connection .....	13
5.2 Configure the Wi-Fi Connection .....	13
5.3 Configure the Cellular Connection .....	14
6. Packet Forwarder Configuration .....	16
7. Network Server Configuration .....	18
7.1 Connect UG56 to Milesight IoT Cloud .....	18
7.2 Connect UG56 to MQTT/HTTP Server .....	20

## 1. Packing List

Before you begin to install the UG56 LoRaWAN® Gateway, please check the package contents to verify that you have received the items below.

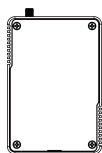

1 × UG56 Device



1 × LoRaWAN®  
Magnetic Antenna

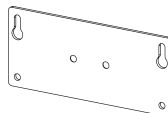

1 × Wall Mounting  
Bracket



2 × M3 Bracket Fixing  
Screws

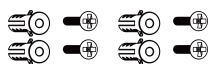

4 × Wall Mounting  
Kits



1 × Quick Start Guide



1 × Warranty Card

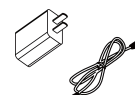

1 × Type-C Cable & Power  
Adapter (Optional)

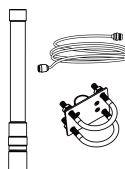

1 × LoRaWAN®  
Fiber-Glass Antenna  
Kit(Optional)



If any of the above items is missing or damaged, please contact your sales representative.

## 2. Hardware Introduction

### 2.1 Overview

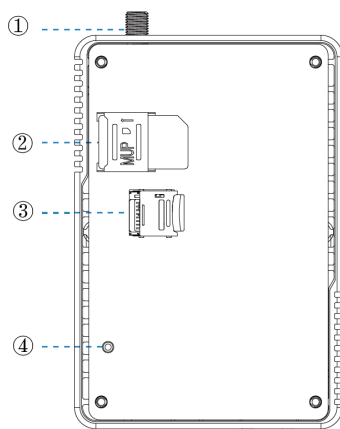

- ① LoRaWAN® Antenna Connector
- ② SIM Slot
- ③ Micro SD Slot
- ④ Reset Button

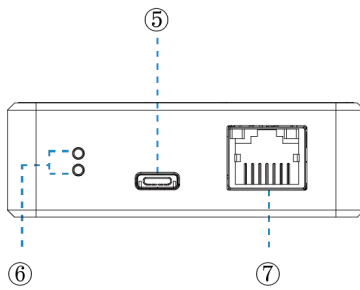

- ⑤ Type-C Power & Console Port
- ⑥ LED Indicators
- ⑦ Ethernet Port (PoE)

## 2.2 Dimensions (mm)

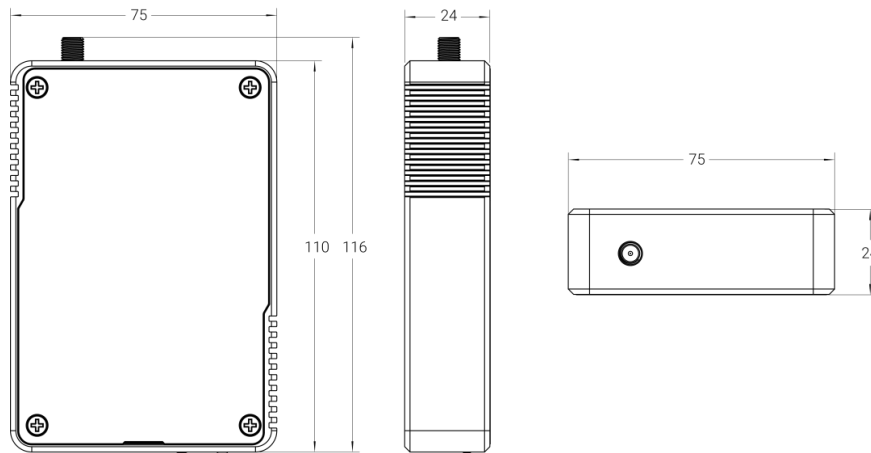

## 2.3 LED Indicators

LED	Indication	Status	Description
SYS	System Status	Off	The system is starting up
		Red Light	The system goes wrong
		Green Light	The system is running properly
LoRa	LoRa Status	Off	Packet Forwarder mode is running off
		On	Packet Forwarder mode is running well
Ethernet Port	Link Indicator (Yellow)	Off	Disconnected or connect failure
		On	Connected
		Blinking	Transmitting data
	Rate Indicator (Green)	Off	Other modes
On		100 Mbps mode	

## 2.4 Reset Button

Function	Description	
	SYS LED	Action
Reset	Static Green	Press and hold the reset button for more than 5 seconds.
	Static Green → Rapidly Blinking	Release the button and wait.
	Off → Static Green	The gateway resets to factory default.

### 3. Hardware Installation

#### 3.1 SIM & Micro SD Installation

Remove the front panel of the device, insert the SIM card or micro SD card into the corresponding slot.

**Note:** UG56 does not support hot plugging (also called hot swapping). please turn off the power before you insert or take off cards.

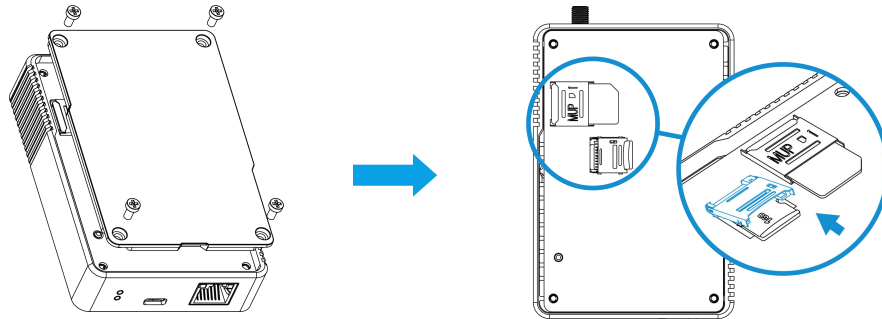

#### 3.2 Antenna Installation

Rotate the LoRa antenna into the antenna connector. The antenna should be installed vertically and kept away from batteries.

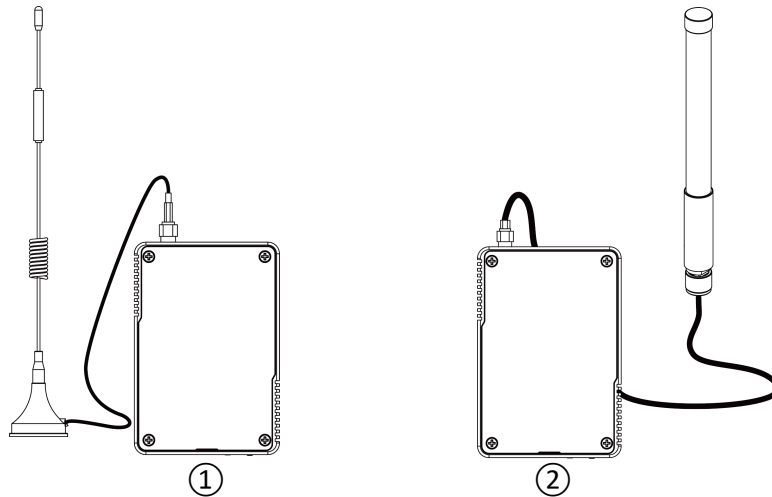

If you need to fix the LoRa fiber-glass antenna to a pole, please pass the LoRa antenna through the antenna clamp and fix it with 4 screws, then wrap the U-bolt around a pole and fix the clamp with nuts and other accessories.

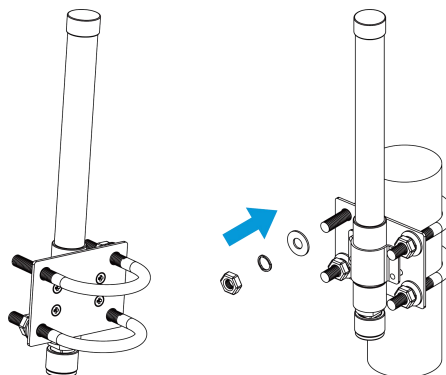

### 3.3 Power Supply

UG56 can be powered by 802.3af standard PoE or Type-C port (5 VDC). If both are connected, the device will be powered by the former method (PoE).

- **Power by a PoE Switch**

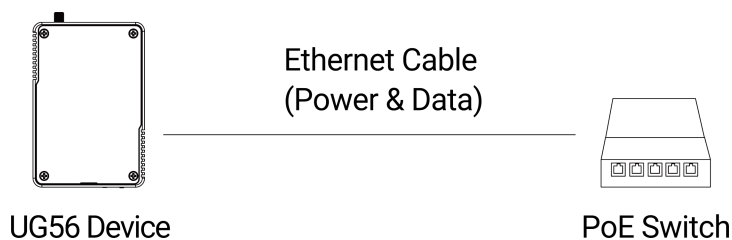

- **Power by a PoE injector**

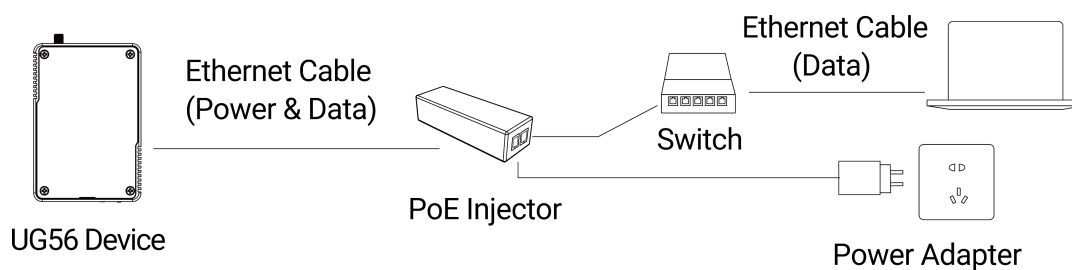

- **Power by a Type-C Port**

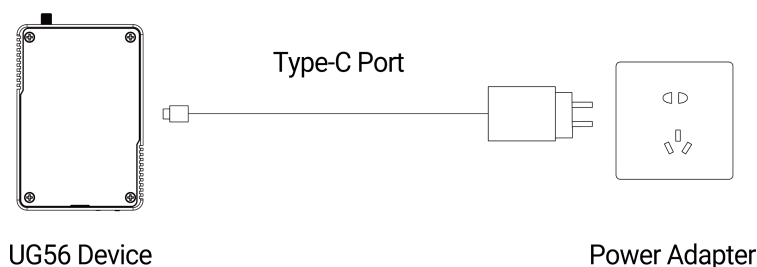

**Note:** When connecting, Ethernet cable of UG56 device side should be installed first, otherwise, PoE devices or gateway may be damaged.

### 3.4 Gateway Installation

Before you get started, make sure all fittings are installed and the power supply is disconnected.

A. Fix the wall mounting bracket to the device with 2 x M3 bracket fixing screws.

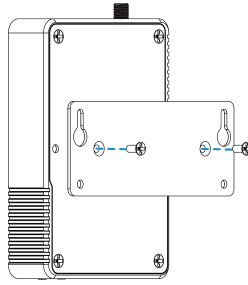

- B. Drill 4 holes on the wall according to the wall mounting bracket, then fix the wall plugs into the wall.
- C. Fix the device to the wall plugs with M3 wall mounting screws. When installation, it's suggested to fix the upper two screws first.

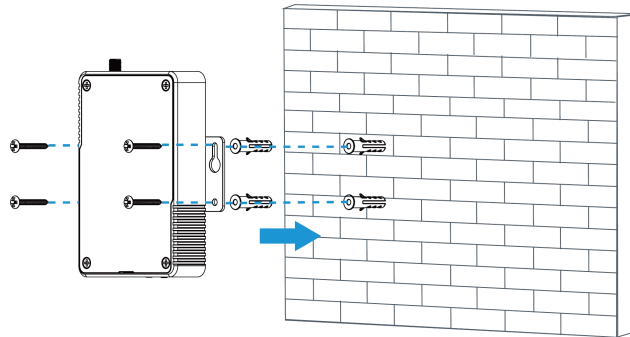



## 4. Web GUI Access

UG56 provides web-based configuration interface for management. If this is the first time you configure the gateway, please use the default settings below:

ETH IP Address: **192.168.23.150**

Wi-Fi IP Address: **192.168.1.1**

Wi-Fi SSID: **Gateway\_\*\*\*\*\***

Username: **admin**

Password: **password**

Browser: **Chrome(recommended)**

### 4.1 Wireless Access

A. Enable wireless network connection on your computer and search for access point “**Gateway\_\*\*\*\*\***” to connect it.

B. Open a web browser on your PC (Chrome is recommended) and type in the IP address **192.168.1.1** to access the web GUI, enter the username and password, click “Login”.

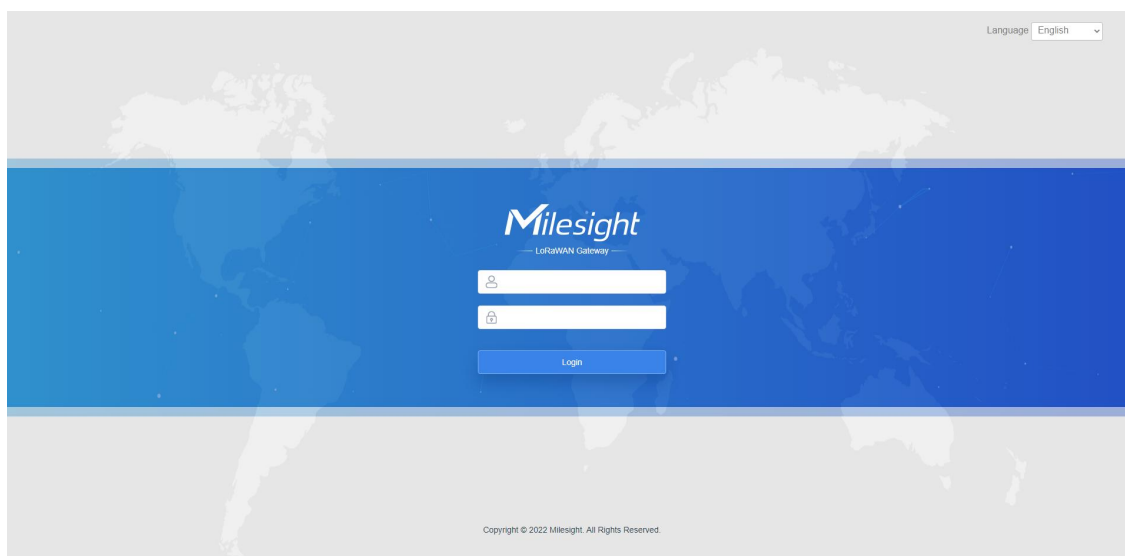

**If you enter the username or password incorrectly more than 5 times, the login page will be locked for 10 minutes.**

D. After logging the web GUI, follow the guide to complete the basic configurations. It's suggested that you change the password for the sake of security.

### Change Your Default Password

For your device security, please change the default password in time.

Old Password

New Password

Confirm New Password

E. You can view system information and perform configuration of the gateway.

admin
↻

For your device security, please change the default password

Status	Overview	Help
Packet Forwarder	Cellular	
Network Server	Network	
Network	WLAN	
System	VPN	
Maintenance	Routing	
APP	Host List	
	Help	

**System Information**

Model	UG56-L00E-915M
Region	US915
Serial Number	6041C2232749
Firmware Version	56.0.0.1-a2
Hardware Version	V1.0
Local Time	2022-08-10 16:31:28 Wednesday
Uptime	03:10:23
CPU Load	6%
RAM (Available/Capacity)	194MB/512MB (37.89%)
eMMC (Available/Capacity)	6.2GB/7.0GB (88.46%)

**Model**  
Show the model name of gateway.

**Region**  
Show the Region of gateway.

**Serial Number**  
Show the serial number of gateway.

**Firmware Version**  
Show the current firmware version of gateway.

**Hardware Version**  
Show the current hardware version of gateway.

**Local Time**  
Show the current local time of system.

**Uptime**  
Show the information on how long the gateway has been running.

## 4.2 Wired Access

Connect PC to UG56 ETH port directly or through PoE injector to access the web GUI of gateway. The following steps are based on Windows 10 system for your reference.

A. Go to "Control Panel" → "Network and Internet" → "Network and Sharing Center", then click "Ethernet" (It may have different names).

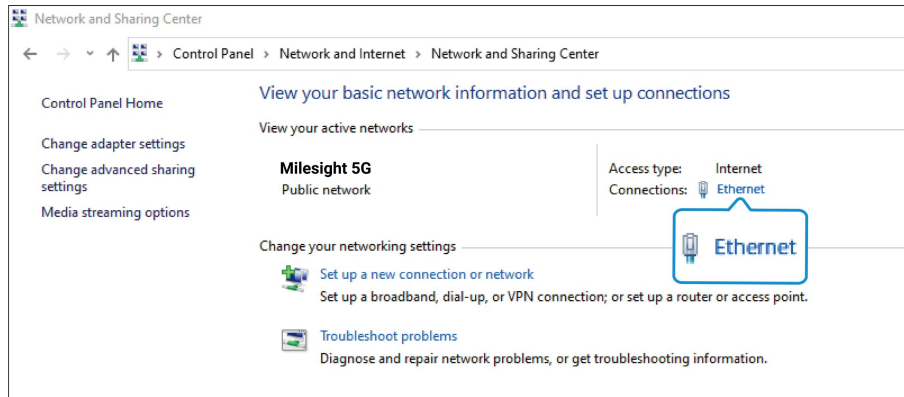

B. Go to “Properties” → “Internet Protocol Version 4 (TCP/IPv4)” and select “Use the following IP address”, then assign a static IP manually within the same subnet of UG56.

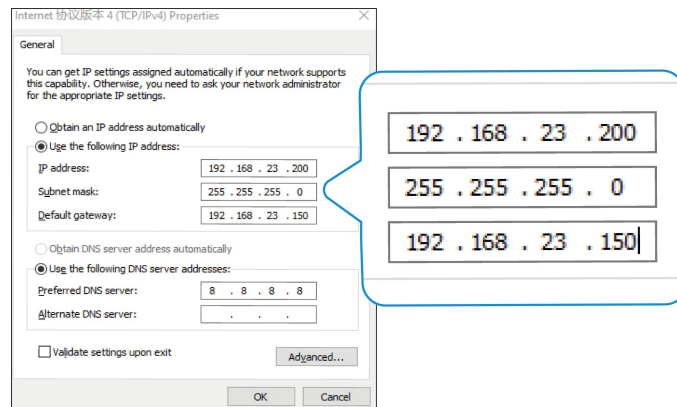

C. Open a Web browser on your PC (Chrome is recommended) and type in the IP address 192.168.23.150 to access the web GUI.

D. Enter the username and password, click “Login”.

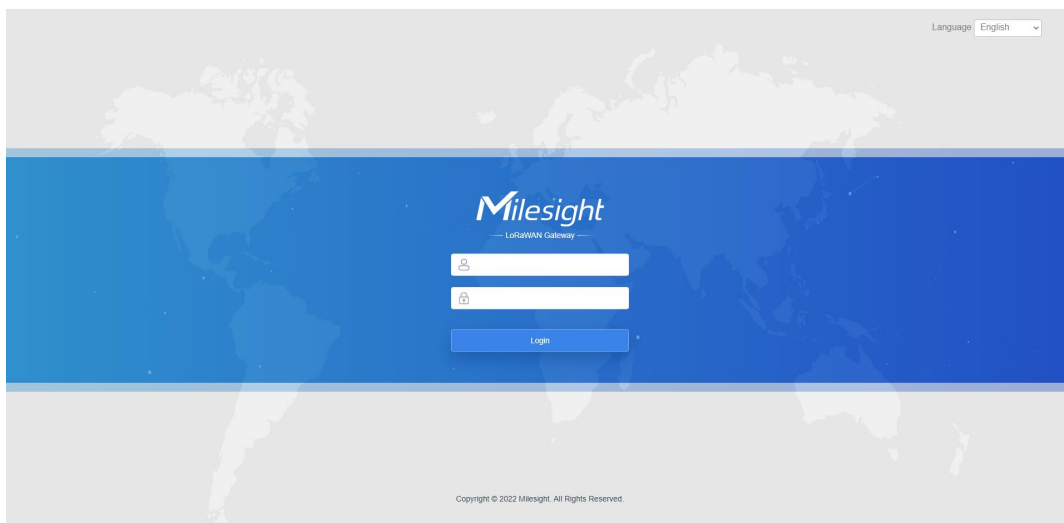

If you enter the username or password incorrectly more than 5 times, the login page will be locked for 10 minutes.

E. After logging the web GUI, follow the guide to complete the basic configurations. It's suggested that you change the password for the sake of security.

### Change Your Default Password

For your device security, please change the default password in time.

Old Password

New Password

Confirm New Password

F. You can view system information and perform configuration of the gateway.

admin🔗

For your device security, please change the default password.

Status	Overview	Cellular	Network	WLAN	VPN	Routing	Host List	Help
Packet Forwarder	<b>System Information</b>							
Network Server	Model	UG56-L00E-915M						<b>Model</b> Show the model name of gateway.
Network	Region	US915						<b>Region</b> Show the Region of gateway.
System	Serial Number	6041C2232749						<b>Serial Number</b> Show the serial number of gateway.
Maintenance	Firmware Version	56.0.0.1-a2						<b>Firmware Version</b> Show the current firmware version of gateway.
APP	Hardware Version	V1.0						<b>Hardware Version</b> Show the current hardware version of gateway.
	Local Time	2022-08-10 16:31:28 Wednesday						<b>Local Time</b> Show the current local time of system.
	Uptime	03:10:23						<b>Uptime</b> Show the information on how long the gateway has been running.
	CPU Load	6%						
	RAM (Available/Capacity)	194MB/512MB (37.89%)						
	eMMC (Available/Capacity)	6.2GB/7.0GB (88.46%)						

Manual Refresh

## 5. Network Connection

This section explains how to connect the gateway to network via WAN connection, Wi-Fi or cellular.

### 5.1 Configure the Ethernet Connection

- Go to “Network” → “Interface” → “Port” page to select the connection type and configure Ethernet port information.
- Click “Save & Apply” for changes to take effect.

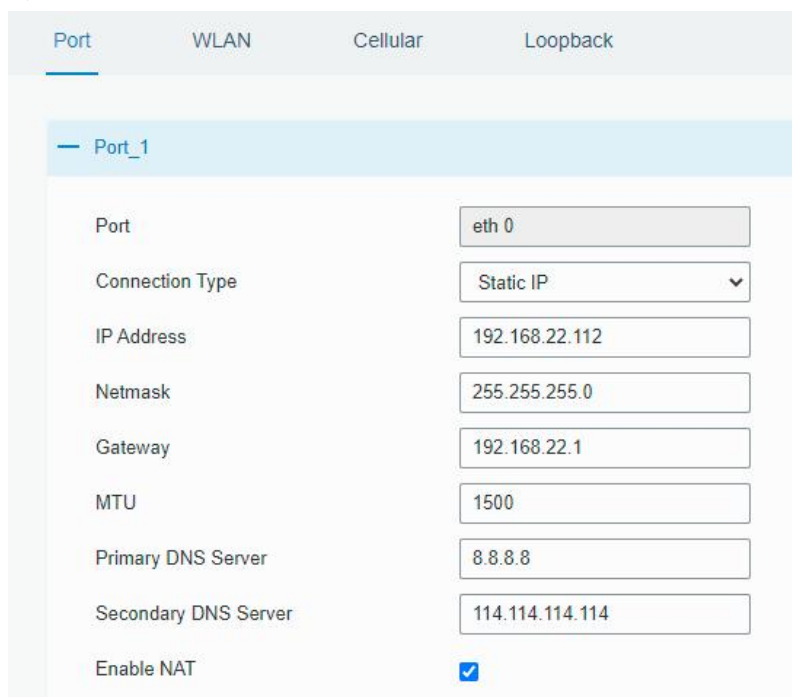

Port	WLAN	Cellular	Loopback
Port_1			
Port	eth 0		
Connection Type	Static IP		
IP Address	192.168.22.112		
Netmask	255.255.255.0		
Gateway	192.168.22.1		
MTU	1500		
Primary DNS Server	8.8.8.8		
Secondary DNS Server	114.114.114.114		
Enable NAT	<input checked="" type="checkbox"/>		

- Connect Ethernet port of gateway to the devices like router or modem.
- Log in the web GUI via the newly assigned IP address and go to “Status” → “Network” to check Ethernet port status.

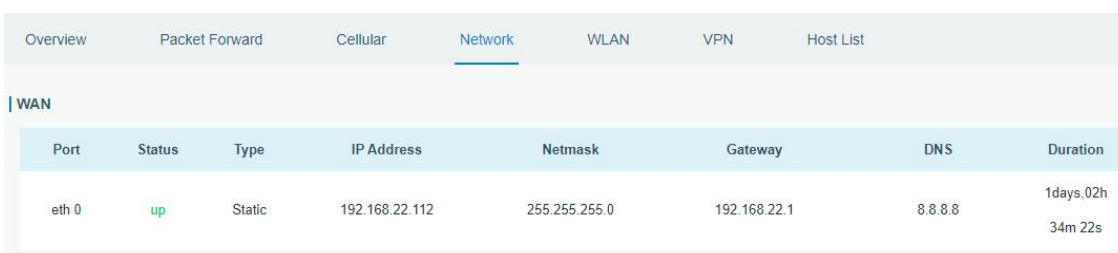

Overview	Packet Forward	Cellular	Network	WLAN	VPN	Host List	
WAN							
Port	Status	Type	IP Address	Netmask	Gateway	DNS	Duration
eth 0	up	Static	192.168.22.112	255.255.255.0	192.168.22.1	8.8.8.8	1days,02h 34m 22s

### 5.2 Configure the Wi-Fi Connection

- Go to “Network” → “Interface” → “WLAN” and select “Client” mode.
- Click “Scan” to search for Wi-Fi access points. Select the available one and click “Join Network”.

Port	WLAN	Cellular	Loopback				
<a href="#">&lt; GoBack</a>							
SSID	Channel	Signal	Cipher	BSSID	Security	Frequency	
AAA	Auto	-61dBm	AES	24:e1:24:f0:c4:13	WPA-PSK/WPA2-PSK	2412MHz	<a href="#">Join Network</a>

C. Type the key of Wi-Fi.

Port	WLAN	Cellular	Loopback
<b>WLAN</b>			
Enable	<input checked="" type="checkbox"/>		
Work Mode	Client		<a href="#">Scan</a>
SSID	AAA		
BSSID	24:e1:24:f0:c4:13		
Encryption Mode	WPA-PSK/WPA2-PSK		
Cipher	AES		
Key	.....		
<b>IP Setting</b>			
Protocol	DHCP Client		

D. Go to "Status" → "WLAN" to check Wi-Fi status. If it shows "Connected", it means gateway connects to Wi-Fi successfully.

Overview	Packet Forward	Cellular	Network	WLAN
<b>WLAN Status</b>				
Wireless Status	Enabled			
MAC Address	24:e1:24:f0:de:14			
Interface Type	Client			
SSID	AAA			
Channel	Auto			
Encryption Type	WPA-PSK/WPA2-PSK			
Cipher	AES			
Status	Connected			
IP Address	192.168.1.145			
Netmask	255.255.255.0			
Connection Duration	0 days, 02:44:45			

## 5.3 Configure the Cellular Connection

A. Go to "Network" → "Interface" → "Cellular" → "Cellular Setting" page to enable cellular settings.

- B. Choose relevant network type and fill in SIM card information like APN or PIN code.  
 C. Click “Save” and “Apply” for changes to take effect.

Port	WLAN	Cellular	Loopback
<b>Cellular Setting</b>			
Enable		<input checked="" type="checkbox"/>	
Network Type		Auto	
APN			
Username			
Password			
Access Number			
PIN Code			
Authentication Type		Auto	
Roaming		<input checked="" type="checkbox"/>	
SMS Center			
Connection Setting		<input type="checkbox"/>	
Enable NAT		<input checked="" type="checkbox"/>	

- D. Go to “Status” → “Cellular” page to view the status of the cellular connection. If it shows “Connected”, it means the SIM has dialed up successfully. On the other hand, you can check the status of LTE indicator. If it keeps on light statically, it means SIM has dialed up successfully.

Overview	Packet Forward	Cellular	Network	WLAN
<b>Modem</b>				
Status		Ready		
Model		EC25		
Version		EC25ECGAR06A07M1G		
Signal Level		23asu (-67dBm)		
Register Status		Registered (Home network)		
IMEI		860425047368939		
IMSI		460019425301842		
ICCID		89860117838009934120		
ISP		CHN-UNICOM		
Network Type		LTE		
PLMN ID				
LAC		5922		
Cell ID		340db83		
<b>Network</b>				
Status		Connected		
IP Address		10.132.132.59		
Netmask		255.255.255.240		
Gateway		10.132.132.60		

## 6. Packet Forwarder Configuration



UG has installed multiple packet forwarders including Semtech, Chirpstack-Generic MQTT broker, etc. This section explains how to connect the gateway to network servers.

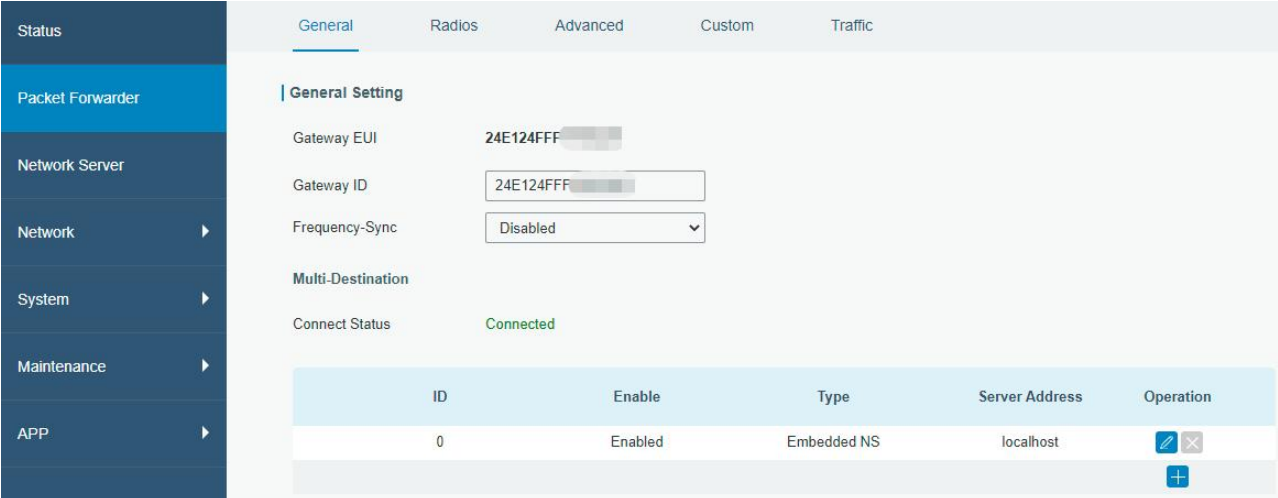

**Make sure the gateway connects to the network as shown in [Section 5](#).**

A. Go to “Packet Forwarder” → “General” page and click  to add a network server.



ID	Enable	Type	Server Address	Operation
0	Enabled	Embedded NS	localhost	 

B. Fill in the server information and enable this server.

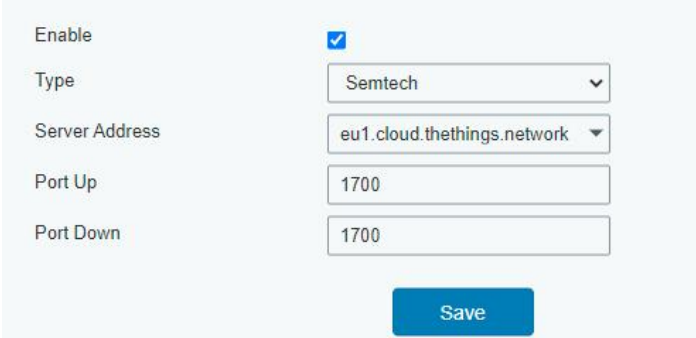

Enable

Type

Server Address

Port Up

Port Down

C. Go to “Packet Forwarder” → “Radio” page, center frequency and channels. The channels of the gateway and network server need to be the same.



Region US915

Name	Center Frequency/MHz
Radio 0	904.3
Radio 1	905.0

**Multi Channels Setting**

Enable	Index	Radio	Frequency/MHz
<input checked="" type="checkbox"/>	0	Radio 0	903.9
<input checked="" type="checkbox"/>	1	Radio 0	904.1
<input checked="" type="checkbox"/>	2	Radio 0	904.3
<input checked="" type="checkbox"/>	3	Radio 0	904.5
<input checked="" type="checkbox"/>	4	Radio 1	904.7
<input checked="" type="checkbox"/>	5	Radio 1	904.9
<input checked="" type="checkbox"/>	6	Radio 1	905.1
<input checked="" type="checkbox"/>	7	Radio 1	905.3

D. Add the gateway on network server page. For more details about the network server connection please refer to [Milesight IoT Support portal](#).

E. Go to "Traffic" page to view the data communication of UG56.

General   Radios   Advanced   Custom   **Traffic**

**Traffic Setting**

Stop
Clear

Rfch	Direction	Time	Ticks	Frequency	Datarate	Coderate	RSSI	SNR
1	up	11:52:38	317882157 1	865.985	SF7BW125	4/5	-91	5.0
1	up	11:52:22	316226269 2	866.585	SF7BW125	4/7	-108	-11.8
0	down	-	311888813 1	865.0625	SF7BW125	4/5	-	-
0	up	11:51:37	311788813 1	865.0625	SF7BW125	4/5	-95	-0.8

## 7. Network Server Configuration

UG56 can work as network server and transmit data to Milesight IoT Cloud or another platform via MQTT/HTTP/HTTPS.



**Make sure the gateway connects to the network as shown in [Section 5](#).**

### 7.1 Connect UG56 to Milesight IoT Cloud

A. Go to “Packet Forwarder” → “General” page to enable the embedded network server.

The screenshot shows the 'General Setting' page for Packet Forwarder. The 'Gateway EUI' is 24E124FFF, 'Gateway ID' is 24E124FF, and 'Frequency-Sync' is Disabled. The 'Multi-Destination' section shows 'Connect Status' as Connected. Below this is a table with the following data:

ID	Enable	Type	Server Address	Operation
0	Enabled	Embedded NS	localhost	

B. Go to “Packet Forwarder” → “Radio” page to select the antenna type, center frequency and channels. The channels of the gateway and nodes need to be the same.

The screenshot shows the 'Radio' configuration page. The 'Region' is set to US915. There are two radio entries:

Name	Center Frequency/MHz
Radio 0	904.3
Radio 1	905.0

Below this is the 'Multi Channels Setting' table:

Enable	Index	Radio	Frequency/MHz
<input checked="" type="checkbox"/>	0	Radio 0	903.9
<input checked="" type="checkbox"/>	1	Radio 0	904.1
<input checked="" type="checkbox"/>	2	Radio 0	904.3
<input checked="" type="checkbox"/>	3	Radio 0	904.5
<input checked="" type="checkbox"/>	4	Radio 1	904.7
<input checked="" type="checkbox"/>	5	Radio 1	904.9
<input checked="" type="checkbox"/>	6	Radio 1	905.1
<input checked="" type="checkbox"/>	7	Radio 1	905.3

C. Go to “Network Server” → “General” page to enable the network server and “Milesight IoT Cloud” mode.

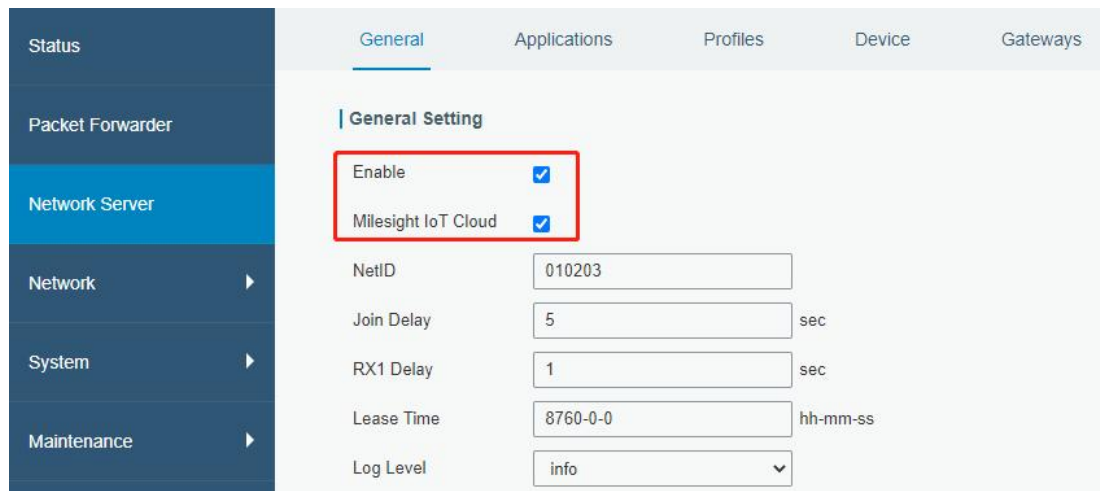

General	Applications	Profiles	Device	Gateways
<b>General Setting</b>				
Enable	<input checked="" type="checkbox"/>			
Milesight IoT Cloud	<input checked="" type="checkbox"/>			
NetID	<input type="text" value="010203"/>			
Join Delay	<input type="text" value="5"/>	sec		
RX1 Delay	<input type="text" value="1"/>	sec		
Lease Time	<input type="text" value="8760-0-0"/>	hh-mm-ss		
Log Level	<input type="text" value="info"/>			

D. Log in the Milesight IoT Cloud. Then go to “My Devices” page and click “+New Devices” to add gateway to Milesight IoT Cloud via SN. Gateway will be added under “Gateways” menu.

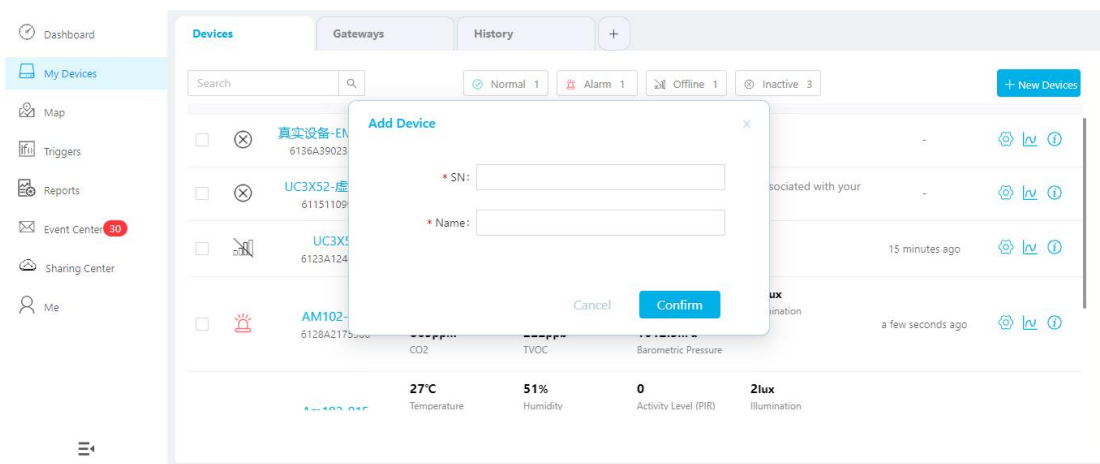

Dashboard

My Devices

Map

Triggers

Reports

Event Center 30

Sharing Center

Me

Devices

Gateways

History

Normal 1

Alarm 1

Offline 1

Inactive 3

+ New Devices

Search

\*SN:

\*Name:

Cancel

Confirm

真实设备-EN 6136A39023

UC3X52-虚 61151109

UC3X5 6123A124

AM102- 6128A2173

CO2

TVOC

Barometric Pressure

27°C Temperature

51% Humidity

0 Activity Level (PIR)

2lux Illumination

E. The gateway is online on Milesight IoT Cloud.

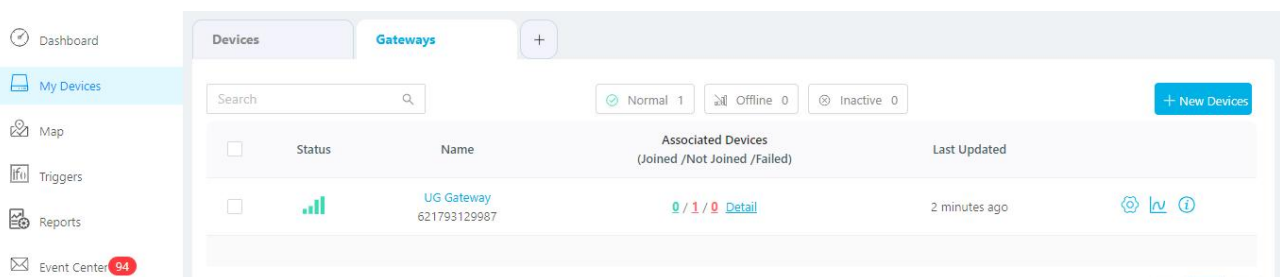

Dashboard

My Devices

Map

Triggers

Reports

Event Center 94

Devices

Gateways

Normal 1

Offline 0

Inactive 0

+ New Devices

Search



Status	Name	Associated Devices (Joined / Not Joined / Failed)	Last Updated
<input type="checkbox"/>	UG Gateway 621793129987	0 / 1 / 0 <a href="#">Detail</a>	2 minutes ago

## 7.2 Connect UG56 to MQTT/HTTP Server

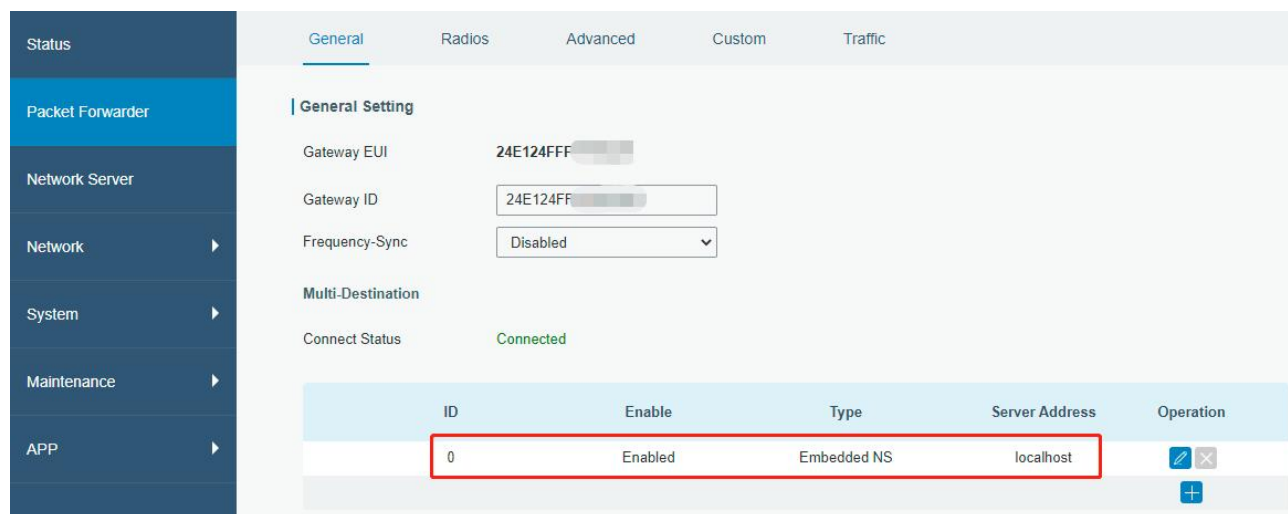
A. Go to “Packet Forwarder” → “General” page to enable the embedded network server.



The screenshot shows the 'General Setting' page for the Packet Forwarder. The 'Connect Status' is 'Connected'. Below the settings, there is a table with the following data:

ID	Enable	Type	Server Address	Operation
0	Enabled	Embedded NS	localhost	 

B. Go to “Packet Forwarder” → “Radio” page to select the antenna type, center frequency and channels. The channels of the gateway and nodes need to be the same.

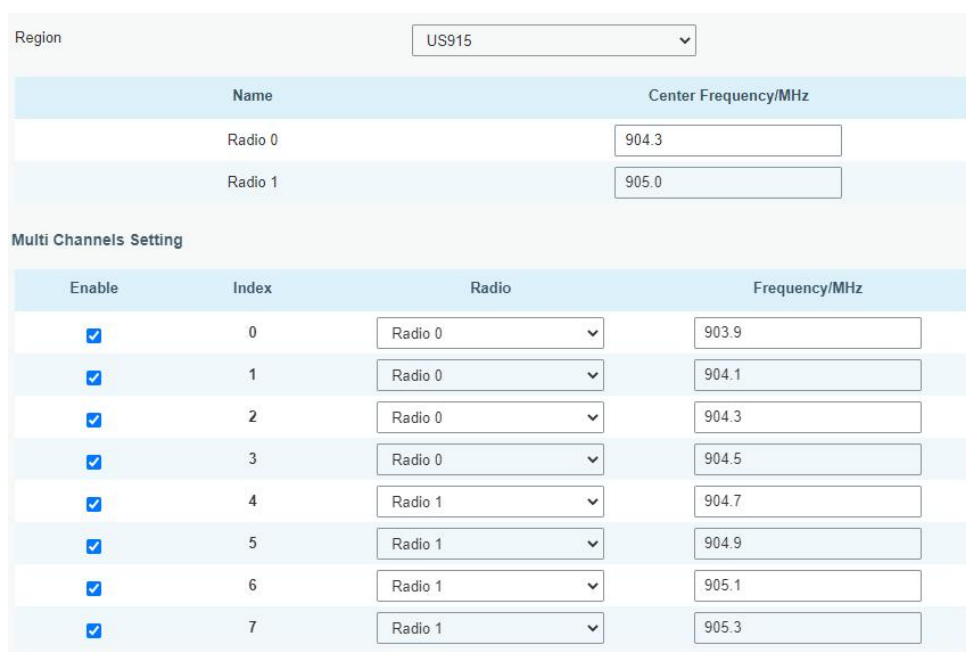

The screenshot shows the 'Radio' page with the 'Region' set to 'US915'. The table below shows the center frequencies for Radio 0 and Radio 1:

Name	Center Frequency/MHz
Radio 0	904.3
Radio 1	905.0

Below this is the 'Multi Channels Setting' table:

Enable	Index	Radio	Frequency/MHz
<input checked="" type="checkbox"/>	0	Radio 0	903.9
<input checked="" type="checkbox"/>	1	Radio 0	904.1
<input checked="" type="checkbox"/>	2	Radio 0	904.3
<input checked="" type="checkbox"/>	3	Radio 0	904.5
<input checked="" type="checkbox"/>	4	Radio 1	904.7
<input checked="" type="checkbox"/>	5	Radio 1	904.9
<input checked="" type="checkbox"/>	6	Radio 1	905.1
<input checked="" type="checkbox"/>	7	Radio 1	905.3

C. Go to “Network Server” → “General” page to enable the network server mode.

The screenshot shows the 'Network Server' configuration page. The left sidebar has 'Network Server' selected. The main content area is titled 'General Setting' and includes the following fields:

Enable	<input checked="" type="checkbox"/>
Milesight IoT Cloud	<input type="checkbox"/>
NetID	<input type="text" value="010203"/>
Join Delay	<input type="text" value="5"/> sec
RX1 Delay	<input type="text" value="1"/> sec
Lease Time	<input type="text" value="876000-0-0"/> hh-mm-ss
Log Level	<input type="text" value="info"/>

D. Go to “Network Server”→“Application” to add a new application.

The screenshot shows the 'Applications' configuration page. The left sidebar has 'Applications' selected. The main content area is titled 'Applications' and includes the following fields:

Name	<input type="text" value="cloud"/>
Description	<input type="text" value="cloud"/>
Payload Codec	<input type="text" value="None"/>

After saving the application, you can select HTTP, HTTPS or MQTT protocol and fill in corresponding server information to send data to another server.

The screenshot shows the 'Data Transmission' configuration page. The left sidebar has 'Data Transmission' selected. The main content area is titled 'Data Transmission' and includes the following fields:

Type	<input type="text" value="MQTT"/>
Status	<input type="text" value="MQTT"/>
Broker Address	<input type="text"/>
Broker Port	<input type="text"/>
Client ID	<input type="text"/>
Connection Timeout/s	<input type="text" value="30"/>
Keep Alive Interval/s	<input type="text" value="60"/>

E. Go to “Profiles” page to add a new profile for the device.

General Applications **Profiles** Device

**Device Profiles**

Name

Max TXPower

Join Type

Class Type  Class A  Class B  Class C

Advanced

**Save** **Cancel**

F. Go to “Device” page and click “Add” to add LoRaWAN® node devices.

General Applications Profiles **Device** Gateways Packets

**Device**

**Add** **Bulk Import** **Delete All**

Device Name	Device EUI	Device-Profile	Application	Last Seen	Activated	Operation
No matching records found						

Device Name

Description

Device EUI

Device-Profile

Application

Frame-counter Validation

Application Key

Device Address

Network Session Key

Application Session Key

Uplink Frame-counter

Downlink Frame-counter

**Save & Apply**

You can also click “Bulk Import” if you want to add many nodes all at once.

Import File  **Browse** **Import** **Template Download**

Click “Template Download” to download template file and add device information to this file. Application

and device profile should be the same as you created on web page.

	A	B	C	D	E	F	G	H	I
1	name	description	deveui	application	deviceprofile	appkey	devaddr	appskey	nwkskey
2	24e1242191323266		24e1242191323266	cloud	ClassC-OTAA	112233445566778899aa112233445566			
3									
4									
5									

Import this file to add bulks of devices.

F. Go to “Packets” page to check the packets from LoRaWAN® node devices. The type starts from “Up” means uplinks and “Dn” means downlinks.

**Network Server**

[Clear](#)

Device EUI	Frequency	Datarate	SNR	RSSI	Size	Fcnt	Type	Time	Details
24e124126a146579	868300000	SF7BW125	8.5	-85	4	14	UpUnc	2020-04-28T15:09:25+08:00	<a href="#">!</a>
24e124126a146579	868300000	SF7BW125	10.2	-75	4	13	UpUnc	2020-04-28T15:04:25+08:00	<a href="#">!</a>

Click “Details” to check the properties and payload contents of packets.

**Packets Details** ✕

Fcnt	14
Port	85
Modulation	LORA
Bandwidth	125
SpreadFactor	7
Bitrate	0
CodeRate	4/5
SNR	8.5
RSSI	-85
Power	-
Payload(b64)	A3cYAA==
Payload(hex)	03771800
MIC	f5acdeb2

**[END]**